



BLACKVUE™

DR590W-2CH

Manual



ENGLISH

www.blackvue.com

Table of Contents

Introduction	5
Important safety information	6
Overview	9
In the box	9
At a glance	10
Front camera	10
Removing and inserting the front camera	11
Rear camera	12
Removing and inserting the rear camera	12
Installation	13
Installing the BlackVue dashcam	13
Playing and Managing Videos	17
Playing and managing video files using your smartphone (Android/iOS)	17
Opening video files	17
BLACKVUE WI-FI screen composition	19
Playing video	20
Playing back videos	20
Identify video files by recording type	20
Checking the displayed time & GPS data	22
Real-time streaming video (Live View)	23
Managing videos	24
Managing videos in BLACKVUE WI-FI	24
Copy to Internal Memory	24
Managing videos in INTERNAL MEMORY	25
Deleting videos	26
Creating a new folder	26
Copying and pasting videos	26
Moving videos	27
Renaming a video	27
Uploading, sharing or emailing a video	27

Playing and Managing Videos	28
Playing and managing video files using your computer (Windows/Mac)	28
Removing the microSD card	28
Opening video files in BlackVue Viewer	29
Viewer screen composition	30
Windows Viewer	30
Mac Viewer	31
Playing video	32
Playing back videos	32
Identify video files by recording type	32
Checking the displayed time	34
Using BlackVue Viewer	34
Exploring the timeline and G-Sensor graph	35
Zoom options	36
Checking the GPS data	37
Managing videos	38
Capturing or printing a still image from video	38
Deleting videos	38
For Windows users	38
For Mac users	39
Exporting videos	40
For Windows users	40
Copying videos	41
For Windows users	41
For Mac users	42
Tips for optimal performance	43
Formatting the microSD card	43
Formatting the card in the BlackVue	43
Format using BlackVue Viewer (Windows)	43
Format using BlackVue Viewer (macOS)	44

Upgrading the firmware..... 46

- Upgrading the firmware using an iOS or Android device (Firmware Over The Air).....46
- Upgrading the firmware using a computer (Windows or Mac).....49

Changing settings52

Changing settings using your smartphone (Android/iOS).. 52

- Basic settings53**
 - Time settings..... 54
 - Video settings 56
 - Resolution 56
 - Image quality 56
 - Night vision 57
 - Brightness (Front) 57
 - Brightness (Rear)..... 57
 - Recording settings..... 58
 - Normal recording 58
 - Automatic parking mode 58
 - Voice recording..... 58
 - Date & time display..... 59
 - Speed unit 59
 - Video segment length..... 59
 - Rear camera rotation..... 59
- Sensitivity settings60**
 - G-Sensor (Normal mode) / G-Sensor (Parking mode) 61
 - Motion detection (Parking mode) 62
- System settings63**
 - LED 63
 - Recording status 63
 - Front security (Normal mode) 63
 - Front security (Parking mode)..... 63
 - Rear security 63
 - Voice guidance 64
 - Impact detected in parking mode..... 64
 - Volume 64
 - Scheduled Reboot..... 64
 - Speed alert 64
 - User text overlay 64

Wi-Fi settings65

- Login credentials..... 65
- Wi-Fi auto turn off 65
- FW Language66**

Changing settings67

Changing settings using your computer (Windows/Mac) ... 67

- BlackVue Viewer settings.....68**
 - Select language 68
 - Speed unit on map..... 68
 - Select map service 68
- Firmware settings69**
 - Basic settings 69
 - Time 70
 - Video settings 70
 - Recording settings..... 71
 - Sensitivity settings 73
 - G-Sensor (Normal mode) / G-Sensor (Parking mode) 73
 - Motion detection (Parking mode) 74
 - Advanced sensitivity settings for normal and parking mode 74
 - System settings 76
 - LED 76
 - Voice guidance 77
 - Impact detected in parking mode 77
 - Volume 77
 - Scheduled Reboot..... 77
 - Speed alert 77
 - User text overlay 77
 - Wi-Fi settings 78
 - Login credentials..... 78
 - Wi-Fi auto turn off 78
 - Applying the settings 78

Optional accessories79

- GPS receiver (Optional).....79
- Parking mode hardwiring kit (Optional)80
- Parking mode battery pack (Optional)81

- Troubleshooting82**
 - Changing / resetting direct Wi-Fi SSID and password 82**
 - On-device Wi-Fi SSID and password reset.....82
 - Change the Wi-Fi password using BlackVue Viewer (Windows or Mac)83
- Product specifications.....84**
- Recording time86**
- Disposal and recycling information.....87**

Introduction

Thank you for purchasing this BlackVue dashcam made by Pittasoft Co., Ltd.

This instruction manual contains information on how to operate your dashcam.

Before using your dashcam, we recommend that you read through this manual to ensure correct usage.

To improve the performance of the product, the contents of this manual are subject to change without prior notice.

Note

- A microSD card is provided with the BlackVue dashcam when you purchase the product. After inserting the microSD card and turning on the dashcam, the microSD card will be initialized.

Important safety information

For user safety and to avoid property damage, read through this manual and follow these safety instructions to use the product correctly.



DANGER

Failure to observe the following directions could result in death or property damage:

- **Do not disassemble, repair, or modify the product yourself.**
Doing so may cause fire, electric shock, or malfunction. For internal inspection and repair, contact the service center.
- **If any foreign matter gets inside the product, detach the power cord immediately.**
Contact the service center for repair.
- **Do not adjust the product while driving.**
Doing so may cause an accident. Stop or park your car in a safe place before installing and setting up the product.
- **Do not install the product in a location where the product can interfere with the driver's field of vision.**
Doing so may cause an accident.
- **Do not use a damaged or modified power cord. Only use the cords provided by the manufacturer.**
Damaged or modified power cords may cause an explosion, fire, or malfunction.
- **Do not operate the product with wet hands.**
Doing so may cause electric shock.
- **Do not install the product in an environment with high humidity, or combustible gases or liquids.**
Doing so may cause an explosion and/or fire.



WARNING Failure to observe the following directions could result in death or serious injury:

- **Do not leave the product near infants, children, or pets.**

There is a risk of them swallowing small components, and/or their saliva may get into the product, causing an explosion due to a short circuit.

- **Do not spray water or wax directly onto the product while cleaning the inside of the car.**

Doing so may cause fire, electric shock, or malfunction.

- **If smoke or an unusual smell is emitted from the power cord, detach the power cord immediately.**

Contact the service center or your distributor.

- **Keep the terminals of the power cord clean.**

Failure to do so may cause excessive heat and fire.

- **Use the correct input voltage.**

Failure to do so may cause explosion, fire, or malfunction.

- **Plug in the power cord firmly so that it cannot easily be disconnected.**

Failure to do so may cause fire.

- **Do not cover the product with any material.**

Doing so may cause external deformation of the product or fire. Use the product and peripherals in a well-ventilated location.

**CAUTION**

Failure to observe the following directions could result in injury or property damage:

- **Do not spray cleaning products directly onto the product.**

Doing so may cause discoloration, cracks, or malfunction.

- **If the product is used outside the optimal temperature range (-20°C – 70°C/-4°F – 158°F), performance can decline or malfunctions may occur.**

- **Make sure that the product is installed properly.**

If installed incorrectly, vibrations may cause the product to fall, and may cause physical injury.

- **When entering or exiting a tunnel, when directly facing into bright sunlight, or when recording at night without lighting the quality of recorded video may deteriorate.**

- **If the product is damaged or the power supply is cut due to an accident, video may not be recorded.**

- **Excessively tinted windshield glass can distort the recorded video or cause recorded video to be indistinct.**

- **Prolonged use of the product can increase the interior temperature and cause burns.**

- **microSD cards are consumables, so replace microSD cards after prolonged use.**

microSD cards may not record video correctly after extended use, so check the microSD card's recording capability periodically and replace as necessary.

- **Clean the lens regularly.**

Foreign material attached to the lens can affect the recording quality.

- **Do not remove the microSD card while the microSD card is saving or reading data.**

The data can be damaged or malfunctions may occur.





- **It is recommended that you install the software and firmware from the BlackVue downloads page (www.blackvue.com).**

- **It is recommended that you remove the power cord if the product is not used for an extended period of time.**

Overview

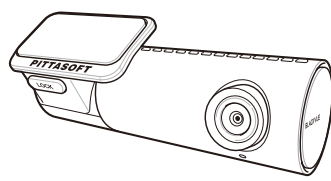
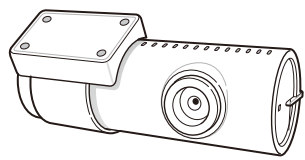
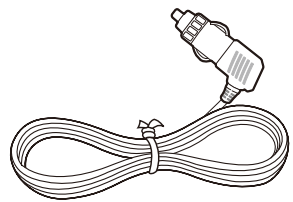
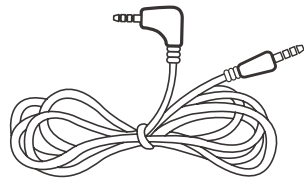
In the box

Check the box for each of the following items before installing the BlackVue dashcam.

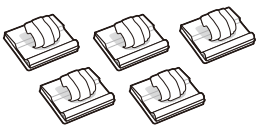
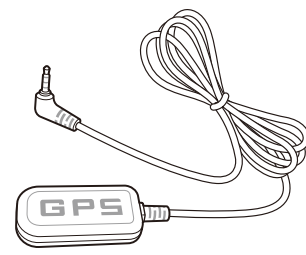
	Front camera		Rear camera		Power cord
	Rear camera connection cable		microSD Card		microSD card adapter
	Quick start guide		Cable clips (5 EA)		External GPS (Optional)

Note

- The illustrations in this manual may differ from the product.
- To improve the performance of the product, the contents of this manual are subject to change without prior notice.
- For more information about the package components and accessories, visit the BlackVue website (www.blackvue.com).

➤ At a glance

The following diagrams explain each part of the BlackVue dashcam.

□ Front camera

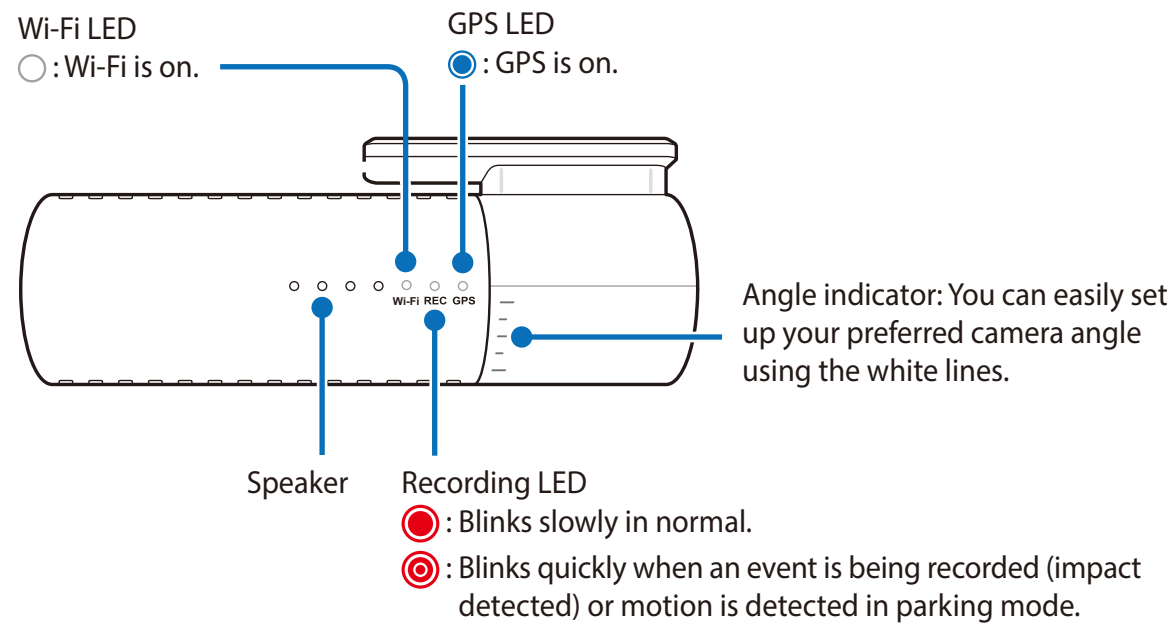
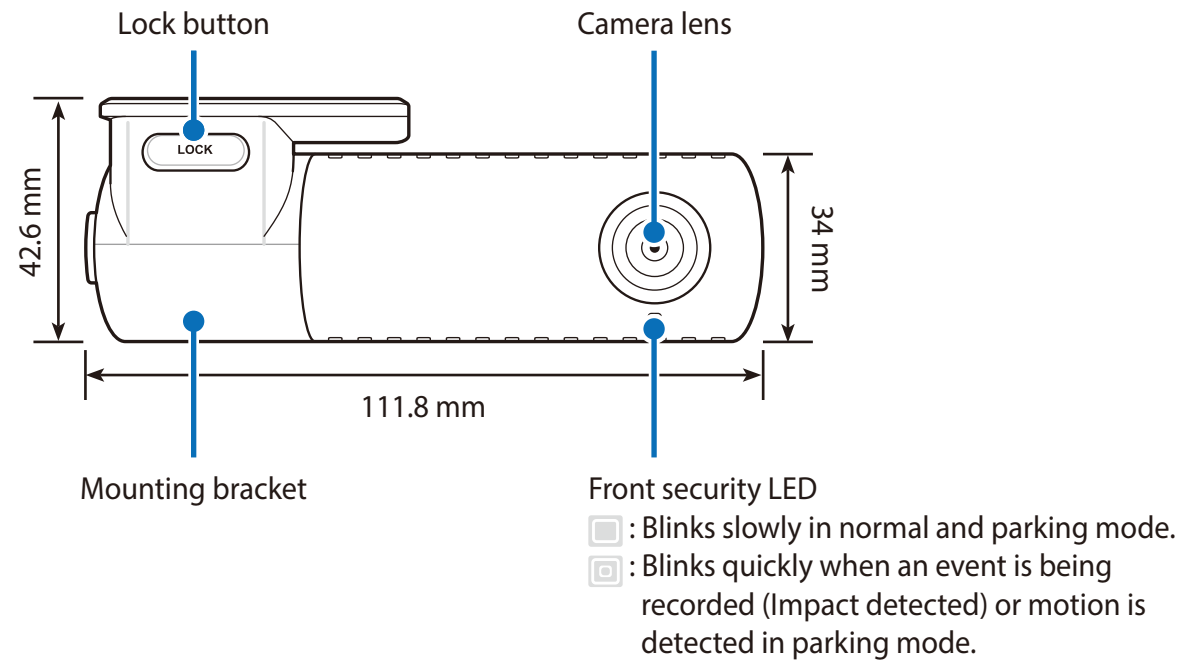

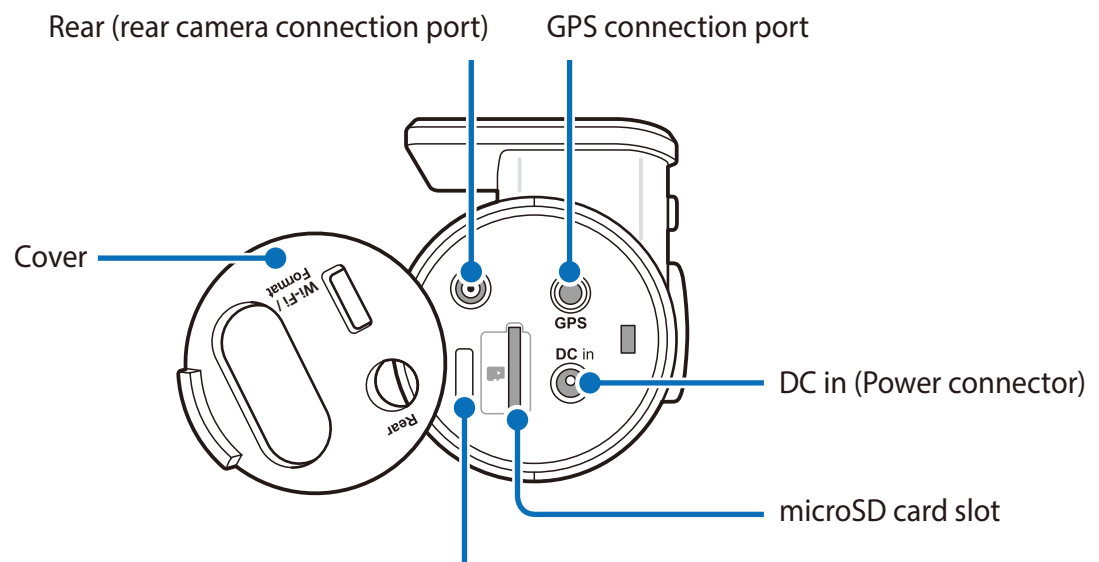

Wi-Fi / Format Button

- Press once to turn on/off Wi-Fi.
- Self-format function: To format the microSD card press the button for 10 seconds until the dashcam beeps.

□ Removing and inserting the front camera

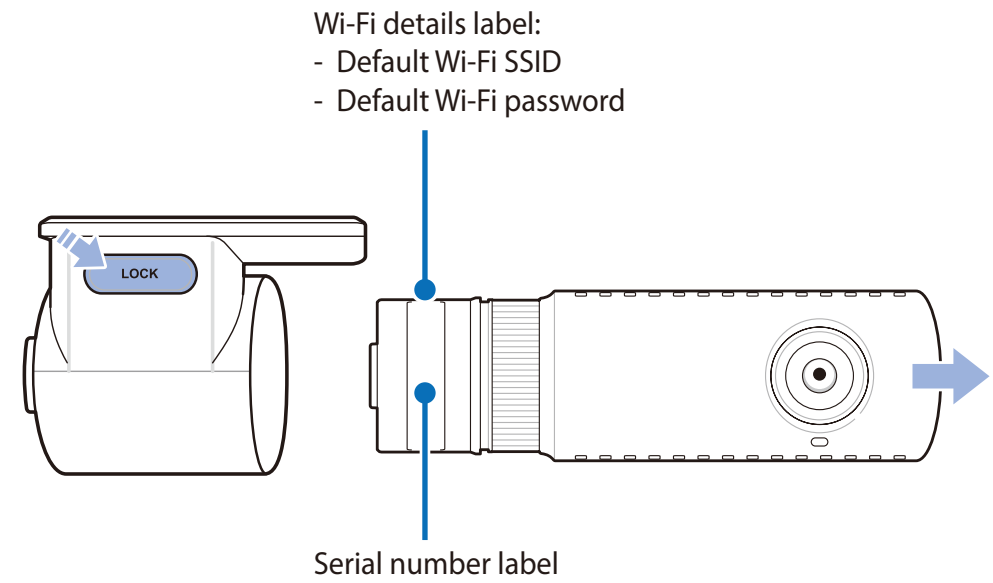

- To remove the front camera from its bracket, press the LOCK button and pull the front camera out of the mounting bracket.
- To insert the front camera into its bracket, push the front camera into the mounting bracket until it "clicks" in.

□ Rear camera

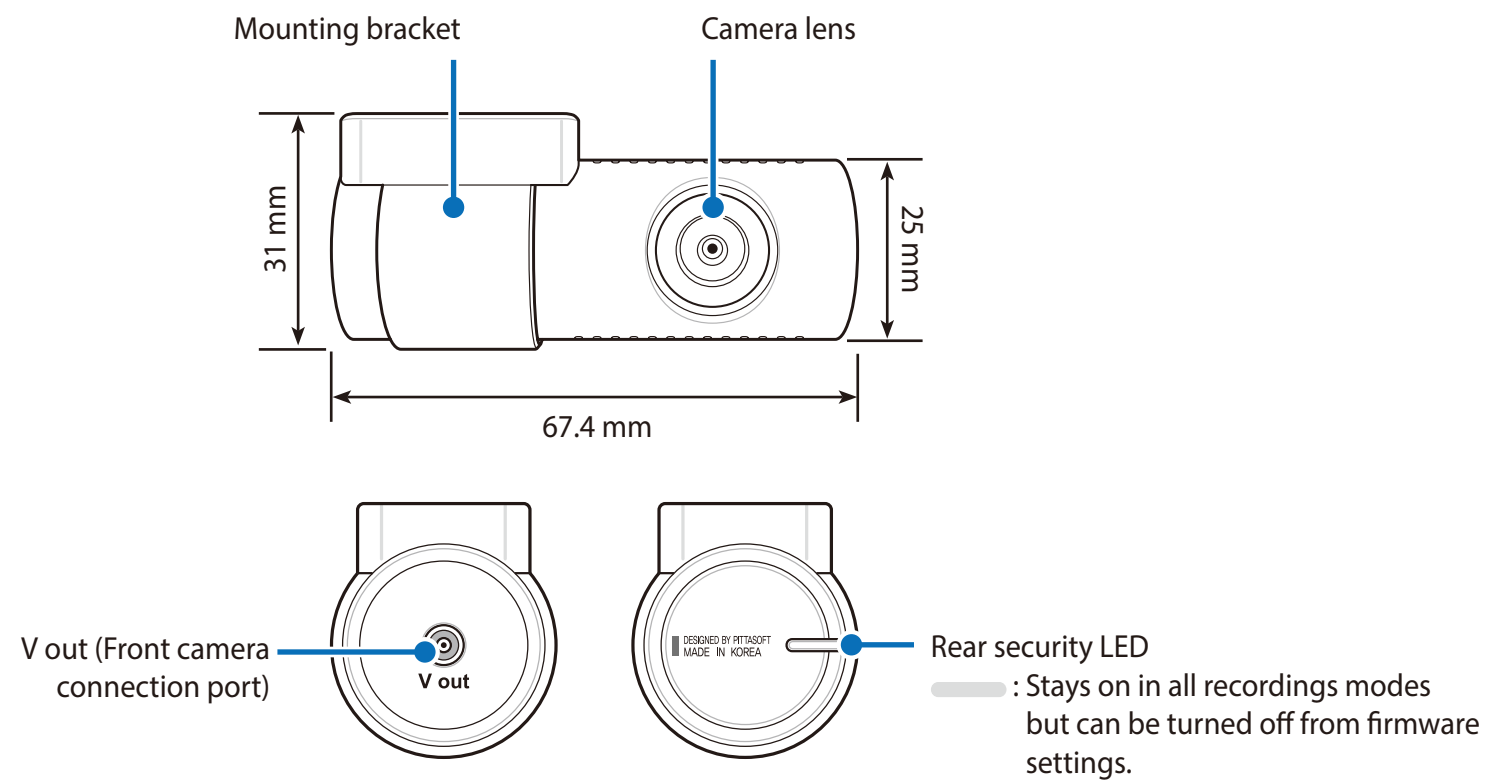

□ Removing and inserting the rear camera

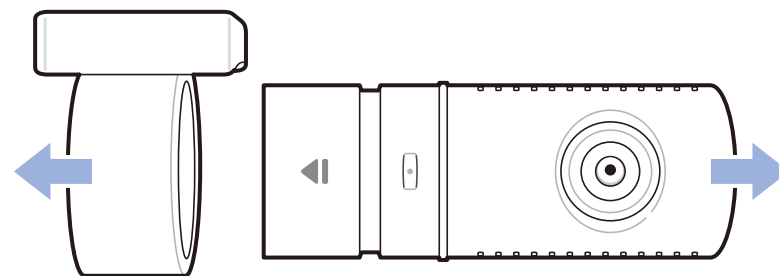

- To remove the rear camera from its bracket, hold the mounting bracket and pull the rear camera out.
- To insert the rear camera into its bracket, push the rear camera into the mounting bracket until it "clicks" in.

Installation

▶ Installing the BlackVue dashcam

Install the front camera behind the rear view mirror. Install the rear camera at the top of the back windshield. Remove any foreign matter and clean and dry the windshield before installation.

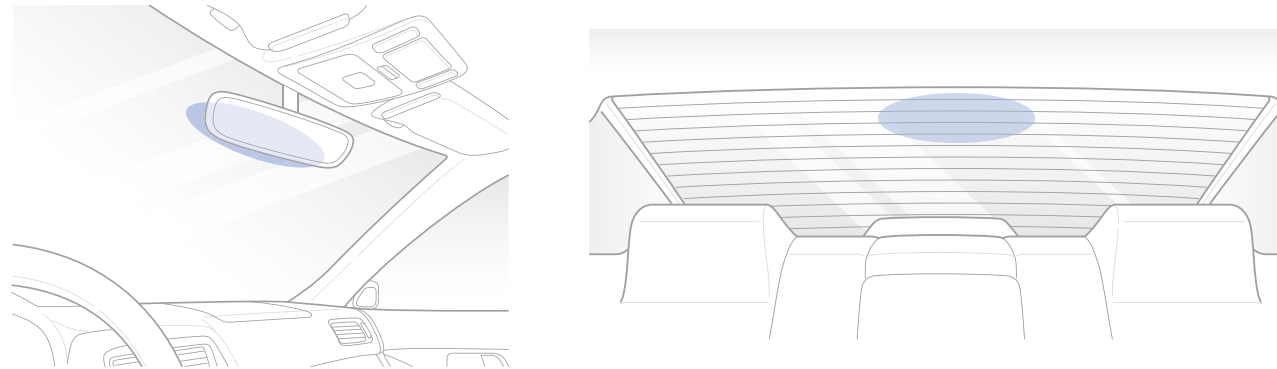

⚠ Warning

- Do not install the product in a location where it can obstruct the driver's field of vision.

- 1 Turn off the engine. Open the cover of the microSD card slot, gently push the card into the slot until it locks into place and close the cover.

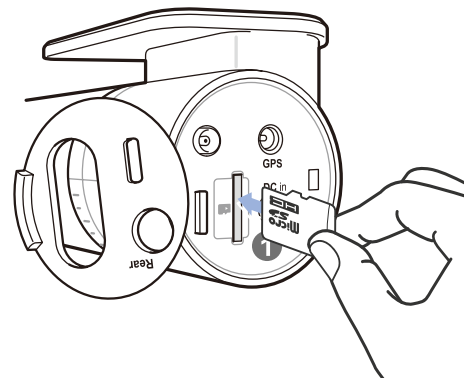

- 2 Peel off the plastic film from the front camera and the rear camera. Peel off the protective film from the double-sided tape and attach the front camera to the windshield behind the rear-view mirror.

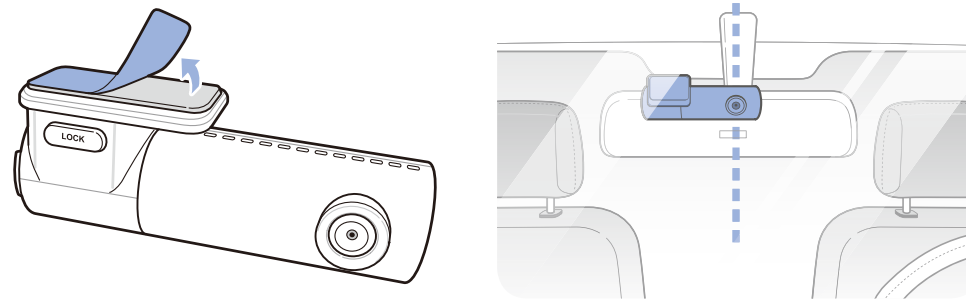

- 3 **Optional GPS receiver:** Plug in the GPS receiver and attach it in a corner of the windshield. Tuck the cable into the windshield trim using the pry tool.

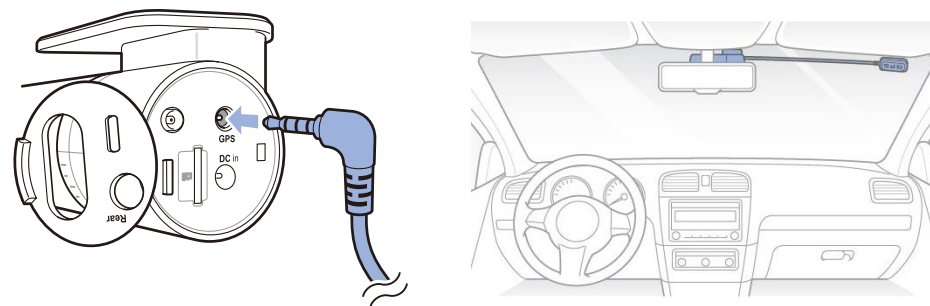

- 4 Adjust the angle of the lens by rotating the body of the front camera. We recommend pointing the lens slightly downwards ($\approx 10^\circ$ below horizontal), so as to record video with a 6:4 road to background ratio.

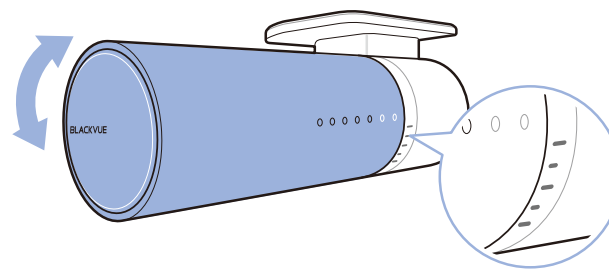

- 5 Peel off the protective film from the double-sided tape and attach the rear camera to the rear windshield. Adjust the angle of the lens by rotating the body of the rear camera.

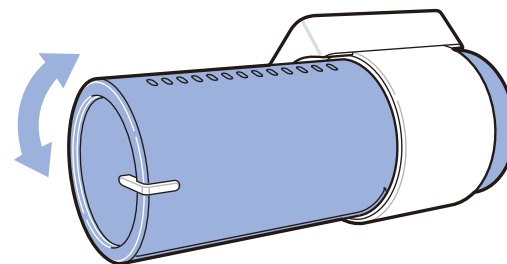

- 6 Connect the front camera ('Rear' port) and the rear camera using the rear camera connection cable.

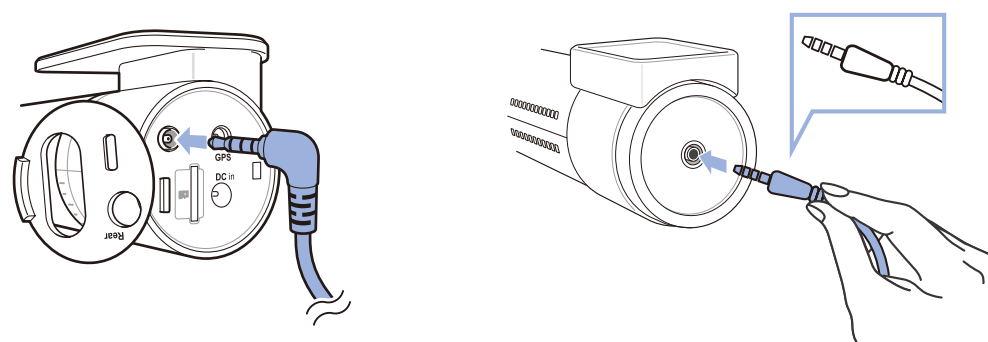

- 7 Use the pry tool to lift the edges of the rubber window sealing and molding and tuck in the rear camera connection cable.

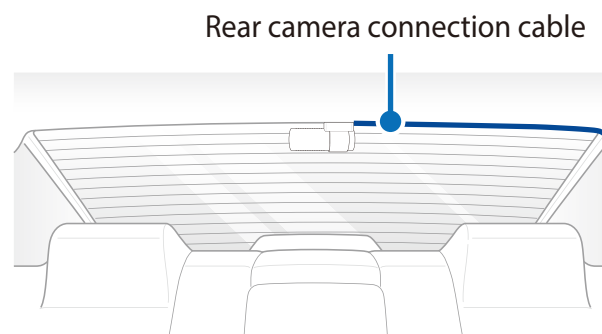

- 8 Plug the power cord into the cigarette lighter socket and the front camera.

- 9 Use the pry tool to lift the edges of the windshield trim/molding and tuck in the power cord.

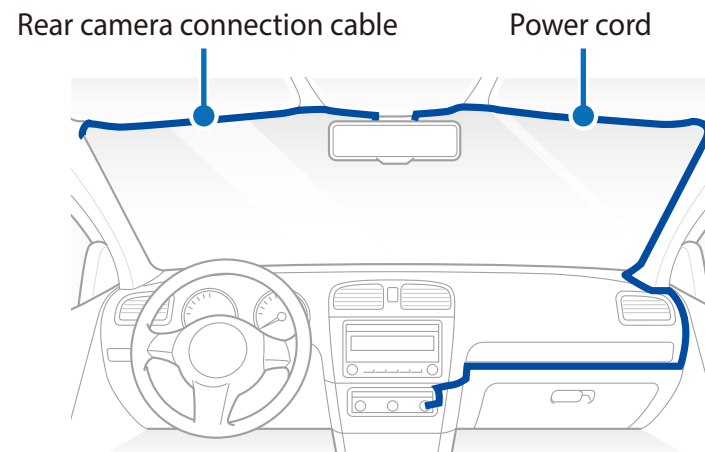

- 10 Turn on the engine. The BlackVue dashcam will power up and start recording. Video files are stored on the microSD card. When the microSD card fills up, the newest video files will start to replace the oldest video files (called **loop recording**) – so you will always have the most recent video files.

 **Note**

- There are 3 recording modes: Normal, Event and Parking. The dashcam starts recording in normal mode, switches to event mode when an impact is detected, and switches to parking mode if the vehicle is stationary for 5 minutes.
- When you run the dashcam for the first time the firmware is automatically loaded onto the microSD card. After the firmware has been loaded onto the microSD card you can customize settings using BlackVue Viewer on a computer.

▶ Playing and managing video files using your smartphone (Android/iOS)

▶ Opening video files

- 1 Search for the BlackVue app in the Google Play Store or Apple App Store and install it on your smartphone.
- 2 “Pair” your smartphone with the BlackVue dashcam via direct Wi-Fi:
 - a. Unplug the power cable and remove the front dashcam from its mount. With the label visible, plug in the power cable and wait for the dashcam to start normal recording. Press the Wi-Fi button once to turn on Wi-Fi.
 - b. Go to your smartphone's **Settings** then select **Wi-Fi**, and make sure Wi-Fi is turned on.

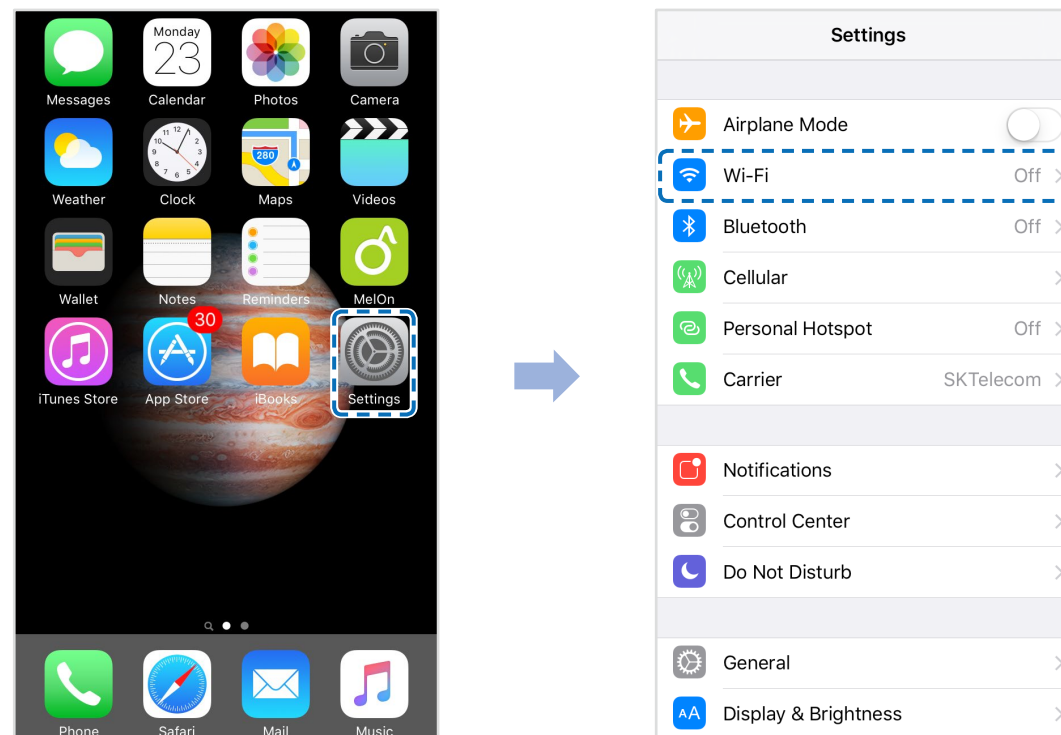

- c. Choose your BlackVue dashcam from the network list. The dashcam's default SSID begins with its model number (e.g. BlackVue****_*****).
 - d. Enter the password and tap join.
- * The default Wi-Fi SSID and password are printed on the dashcam's label.
- e. Open the BlackVue app and select BLACKVUE WI-FI.

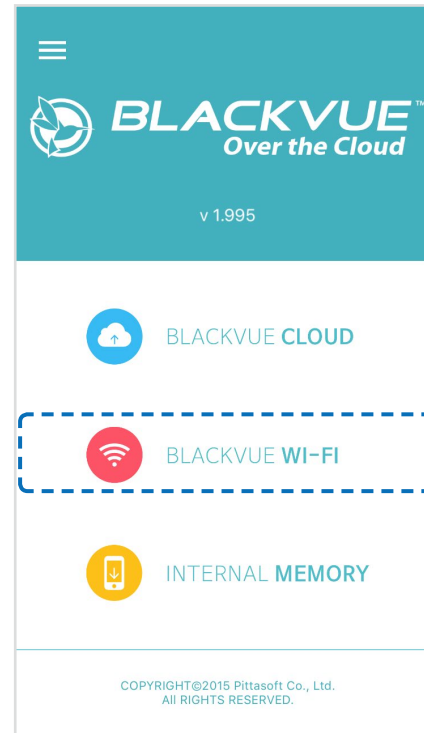

 **Note**

- Direct Wi-Fi lets you directly connect your smartphone to your dashcam via Wi-Fi within a range of 10m.
- The BlackVue app is available for devices running Android 4.4.2 and higher, or iOS 9.0 and higher.
- You can change the Wi-Fi SSID and password as described on page **83**.

BLACKVUE WI-FI screen composition

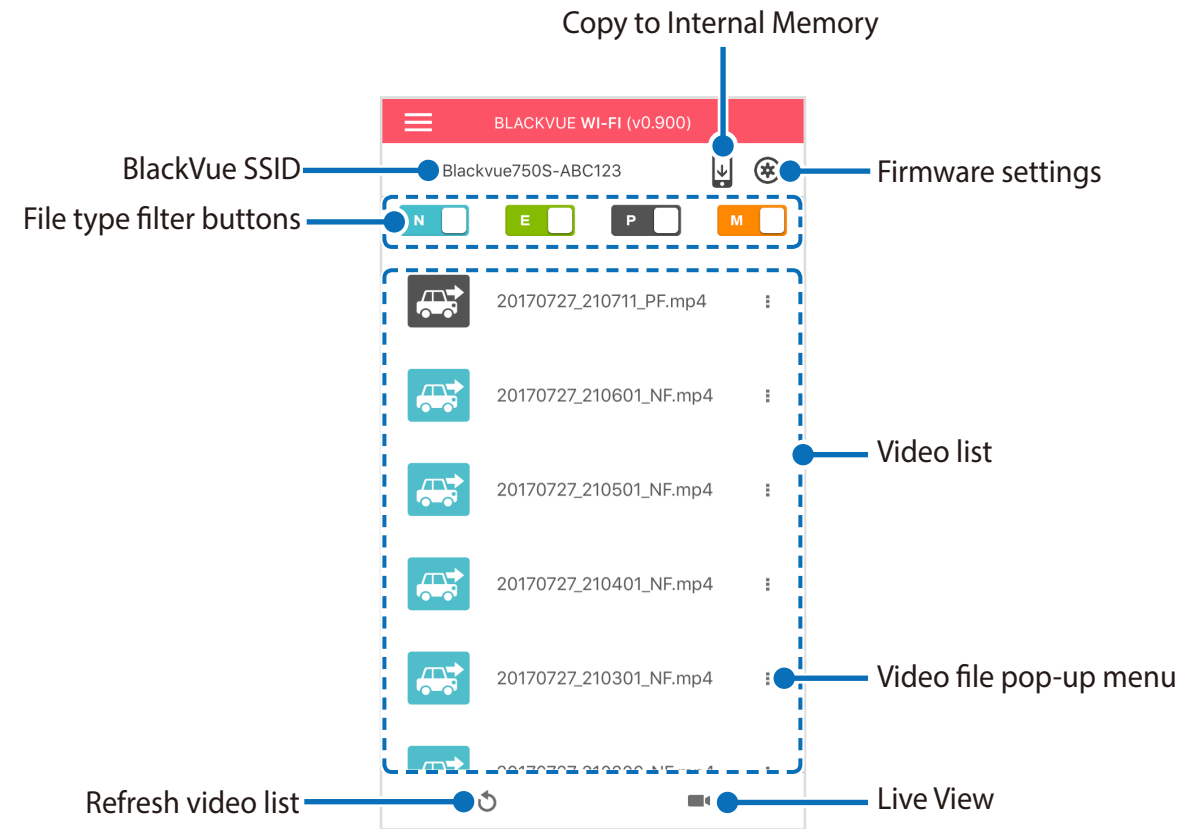

Note

- All images shown are for illustration purposes only. Actual app may differ from images shown.



▶ Playing video

□ Playing back videos

Select the video file you want to play from the video list.

Press the refresh button  to refresh the video list.

□ Identify video files by recording type

	Normal	The dashcam records in normal mode by default.
	Event	When the dashcam detects an impact while in normal or parking mode, it switches to event mode and saves an event recording beginning 5 seconds before the event trigger. Exceeding the set speed limit will also trigger an event recording.
	Parking	In parking mode the dashcam continuously buffers video. When motion is detected in the dashcam's field of view, it saves a parking recording beginning 5 seconds before the motion detection.

Tap the car icon to load the thumbnail of a recording.

The car icon with an arrow pointing to the right indicates a front dashcam recording.



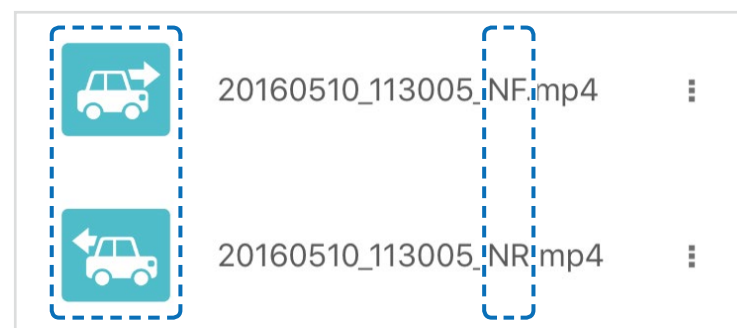

The car icon with an arrow pointing to the left indicates a rear dashcam recording.



Recording file names include the date, time, recording type and camera direction.

- **Recording type:** N: Normal
E: Event
P: Parking mode motion detection
- **Camera direction:** F: Front camera
R: Rear camera
- **Example file name:** 20170104_150838_NF.mp4
Date & time: 4th January 2017, 03:08:38 PM
Recording type: Normal
Camera direction: Front camera

Note

- Use the , , , buttons to filter the video list by recording type (Normal, Event, Parking). The  filter button displays both E (Event) and I (Impact event while parked) recordings.
- The dashcam requires a constant power source to record in parking mode. See "**Optional accessories**" on page 79 for more information.

☐ Checking the displayed time & GPS data

The time the video was recorded is displayed in the lower left corner of the video in the playback screen. If the displayed time in the recorded videos is incorrect please see **"Time settings" on page 54 or 70.**

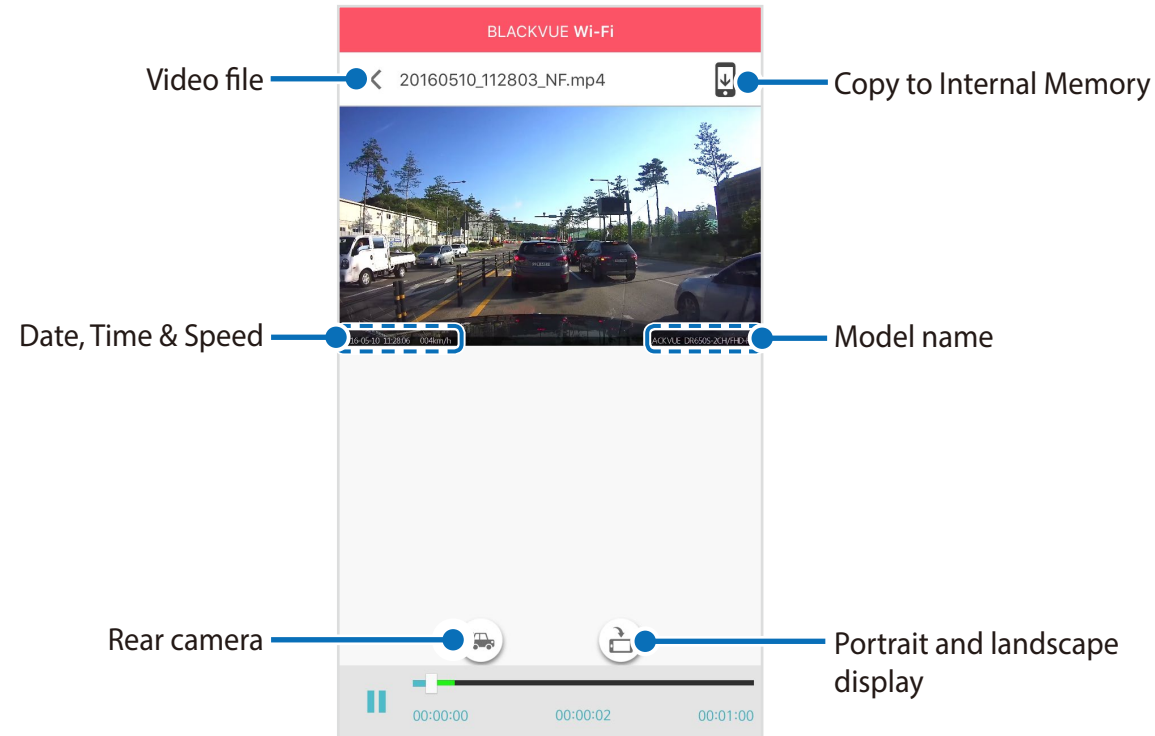

The vehicle's speed is displayed in the lower-left corner of the video.



Rotate your smartphone or press the rotate button  to switch between portrait and landscape display modes.

Press the rear button  to switch to the rear dashcam view.

➤ Real-time streaming video (Live View)

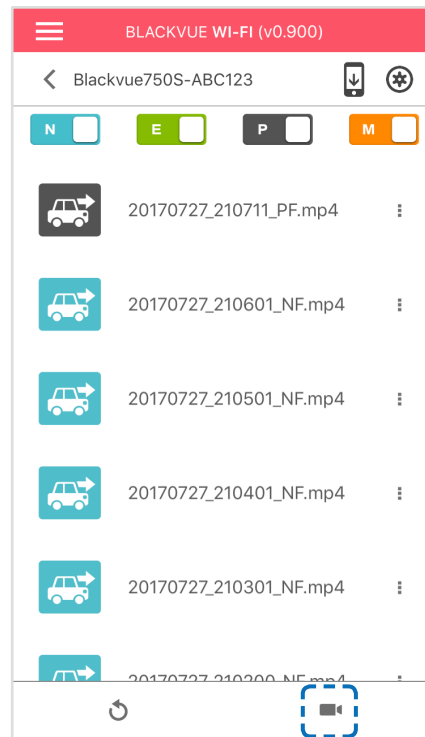
You can view in real-time the video currently being recorded by connecting your smartphone to the dashcam via direct Wi-Fi.



- 1 Go to your smartphone's **Settings** > **Wi-Fi** and connect to your dashcam.
- 2 Open the BlackVue app. Select **BLACKVUE WI-FI** and tap the  button.
- 3 Rotate your smartphone or press the rotate button  to switch between portrait and landscape display modes.
- 4 Press the rear button  to switch to the rear dashcam view.

Note

- When watching Live View via direct Wi-Fi, map data isn't displayed because your smartphone can't access the internet as long as it is connected to the dashcam's Wi-Fi.

➤ Managing videos

☐ Managing videos in BLACKVUE WI-FI

You can manage the recorded videos using the BlackVue app.

📝 Note

- When the microSD card fills up, the newest video files will start to replace the oldest video files (called loop recording) – so you will always have the most recent video files.

■ Copy to Internal Memory

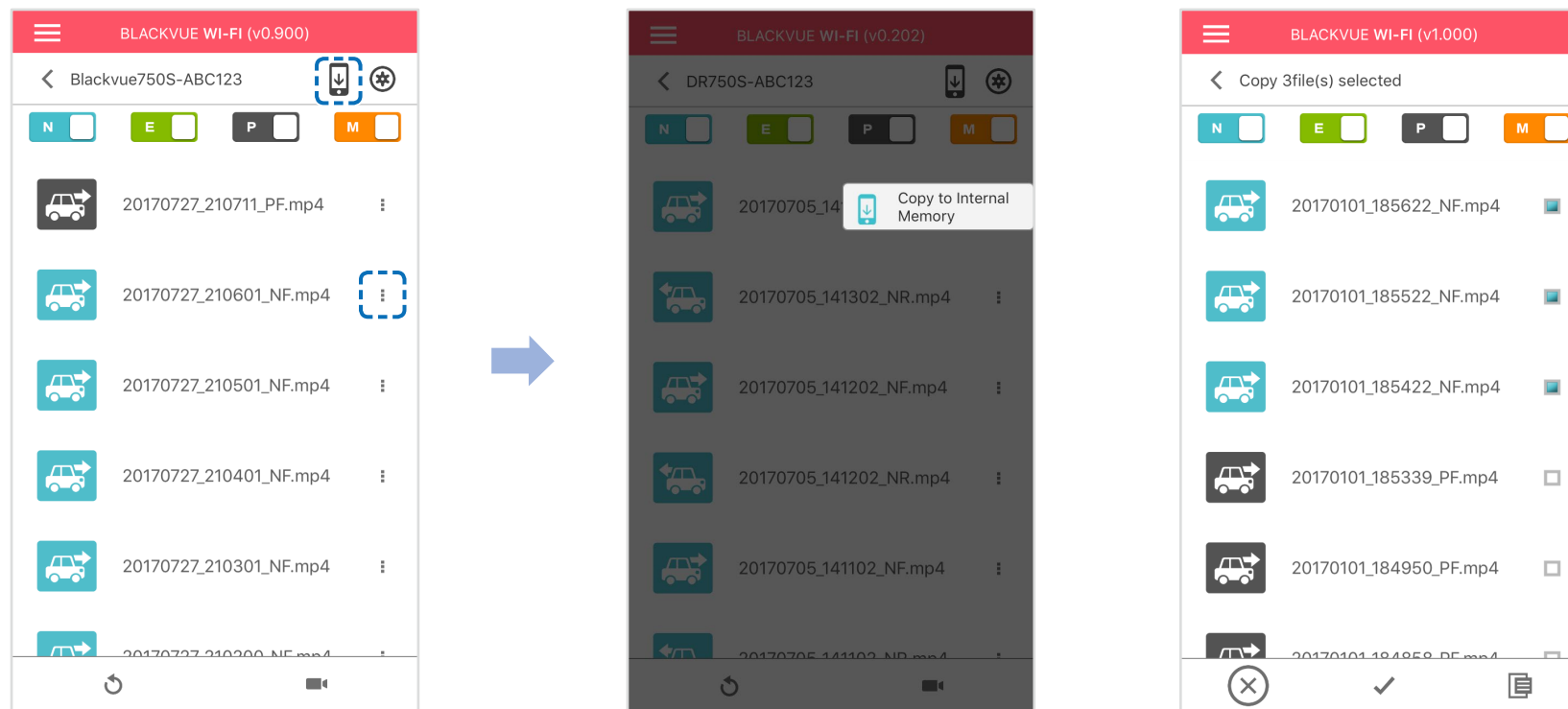



To copy individual files to your smartphone, tap  next to the video you want to copy. Select Copy to Internal Memory.

To copy multiple files to your smartphone in one go tap . Select which files to copy, or tap  to select all files. Tap  to begin copying.

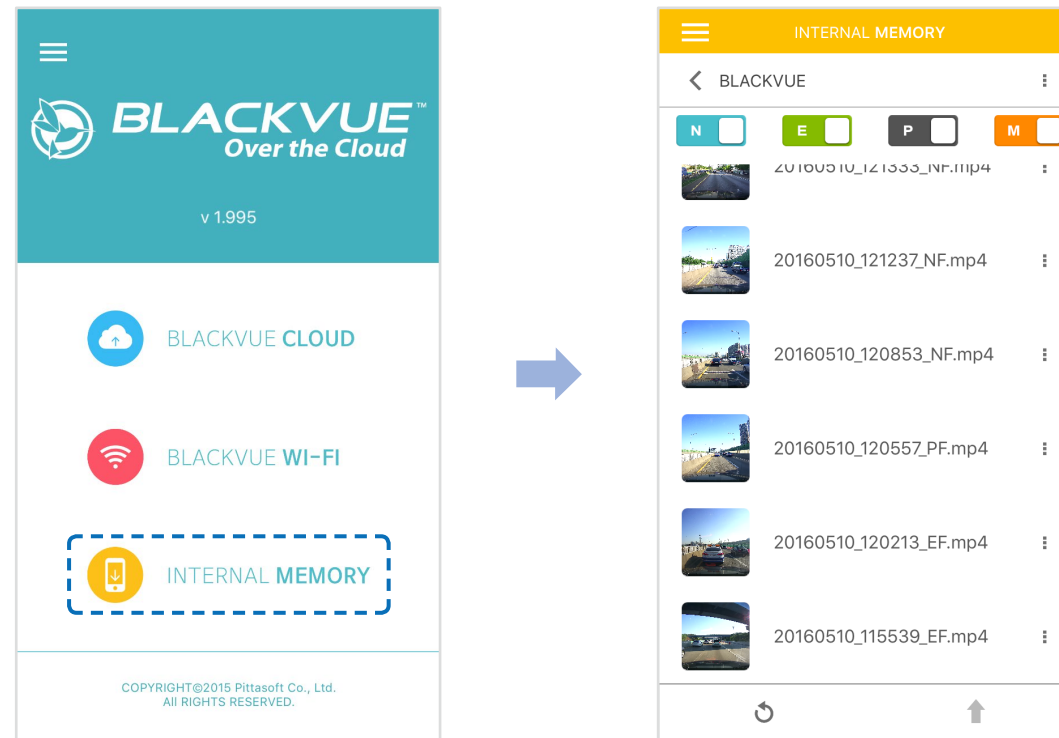

Managing videos in INTERNAL MEMORY

Open the BlackVue app and select INTERNAL MEMORY.



Tap  to see file options. You can delete, copy or move files, change the name of files and share files.

■ Deleting videos

To delete multiple files from your smartphone in one go, tap  at the top of the screen and select **Delete**. Select which files to delete, or tap  to select all files. Tap  to delete the selected files.



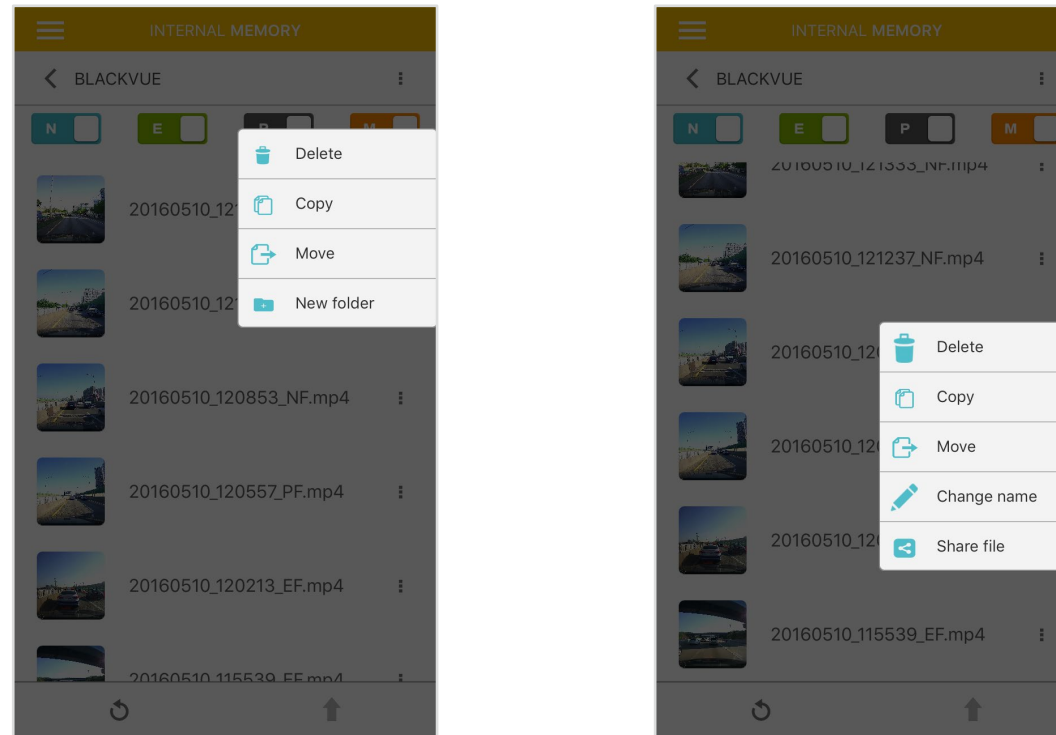

To delete individual files, tap  next to the video you want to delete. Select **Delete**.



■ Creating a new folder





To create a new folder tap  at the top of the screen and select **New folder**. Enter a new folder name and press OK.

■ Copying and pasting videos

To copy multiple files in one go, tap  at the top of the screen and select **Copy**. Select which files to copy, or tap  to select all files. Tap  to copy the selected files. Go to another folder and tap  to paste the selected files there.

To copy individual files, tap  next to the video you want to copy. Select **Copy**. Go to another folder and tap  to paste the file there.

■ Moving videos

To move multiple files in one go, tap  at the top of the screen and select **Move**. Select which files to move, or tap  to select all files. Tap  and go to another folder and tap  to move the selected files there.

To move individual files, tap  next to the video you want to move. Select **Move**. Go to another folder and tap  to move the file there.

■ Renaming a video

To rename a video, tap  next to the video you want to rename. Select **Change name**. Enter a new name and tap **OK**.

■ Uploading, sharing or emailing a video

Tap  next to the video you want to share. Select **Share file**. Choose the app you want to share with. The available options will depend on what apps you have installed on your smartphone.

Playing and Managing Videos

▶ **Playing and managing video files using your computer (Windows/Mac)**

➤ **Removing the microSD card**

- 1 Unplug the power cord to turn off the dashcam.
- 2 Open the cover of the microSD card slot.
- 3 To remove the microSD card, gently press on the card to release the lock then carefully pull the card out.
To insert the microSD card, gently push the card into the slot until it locks into place and close the side cover.

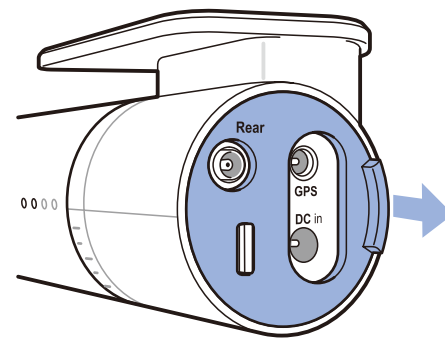

Open side cover

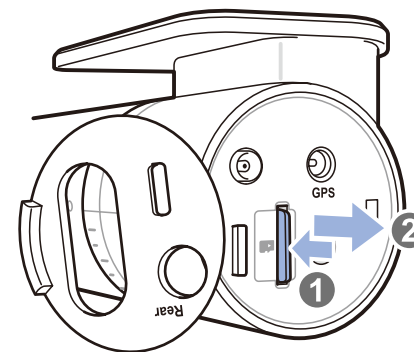

To remove

➤ Opening video files in BlackVue Viewer

- 1 Remove the microSD card from the dashcam.
- 2 Use the included microSD card adapter to connect the card to a computer.

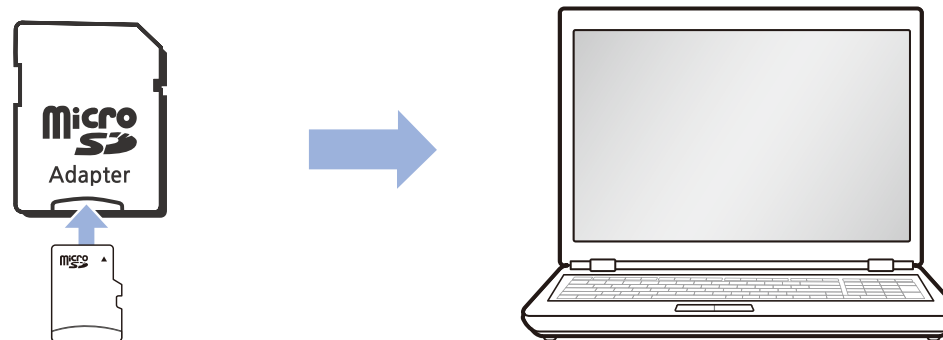

- 3 Download BlackVue Viewer from www.blackvue.com > **Support** > **Downloads** and install it on your computer.
- 4 Run BlackVue Viewer.

Viewer screen composition

Windows Viewer

When you launch the program, you will see the SD card Viewer window. To open Cloud Viewer, click the  button.

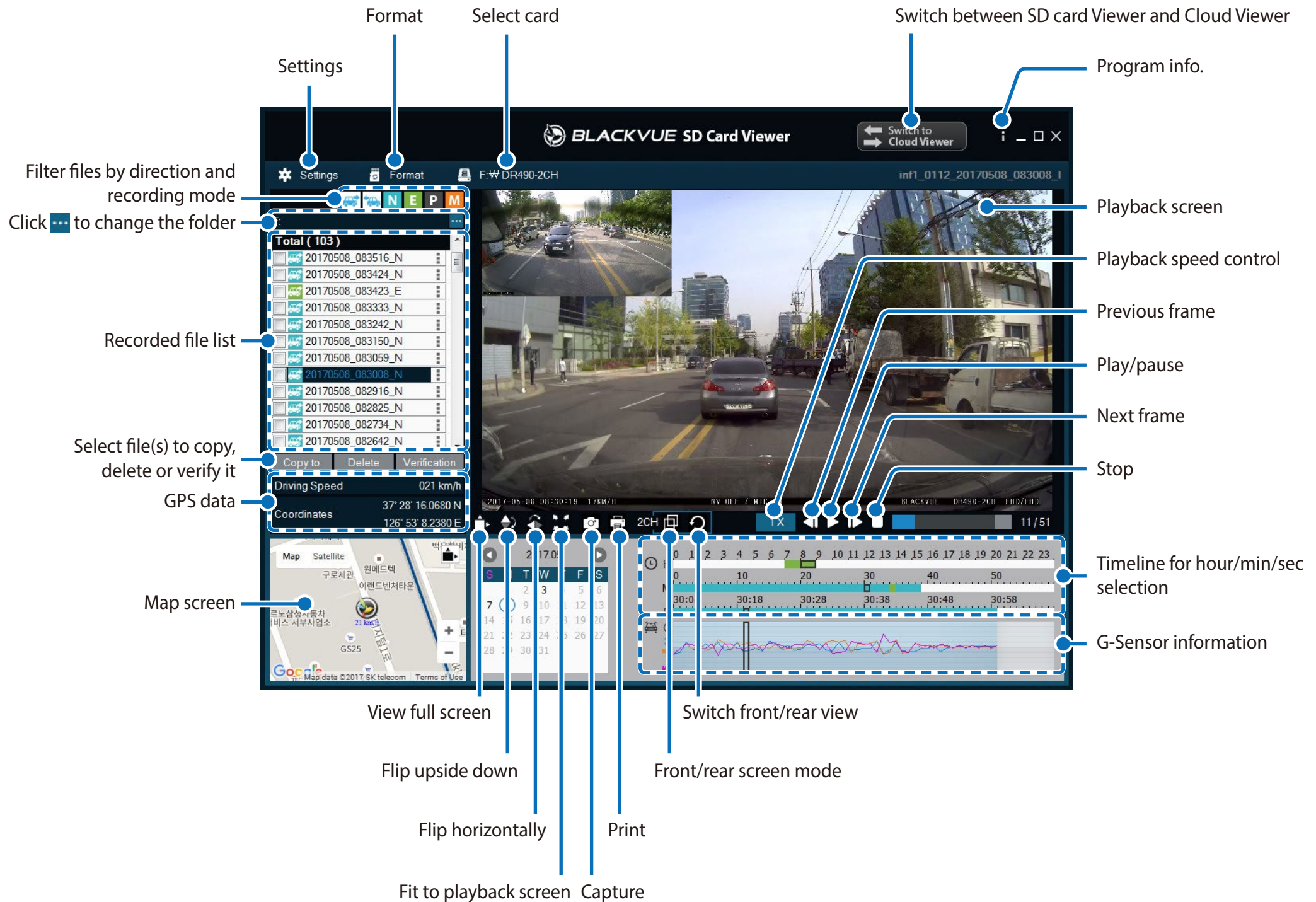

Note

- All images shown are for illustration purposes only. Actual program may differ from images shown.

Mac Viewer

When you launch the program, you will see the SD card Viewer window. To open Cloud Viewer, click the  button.

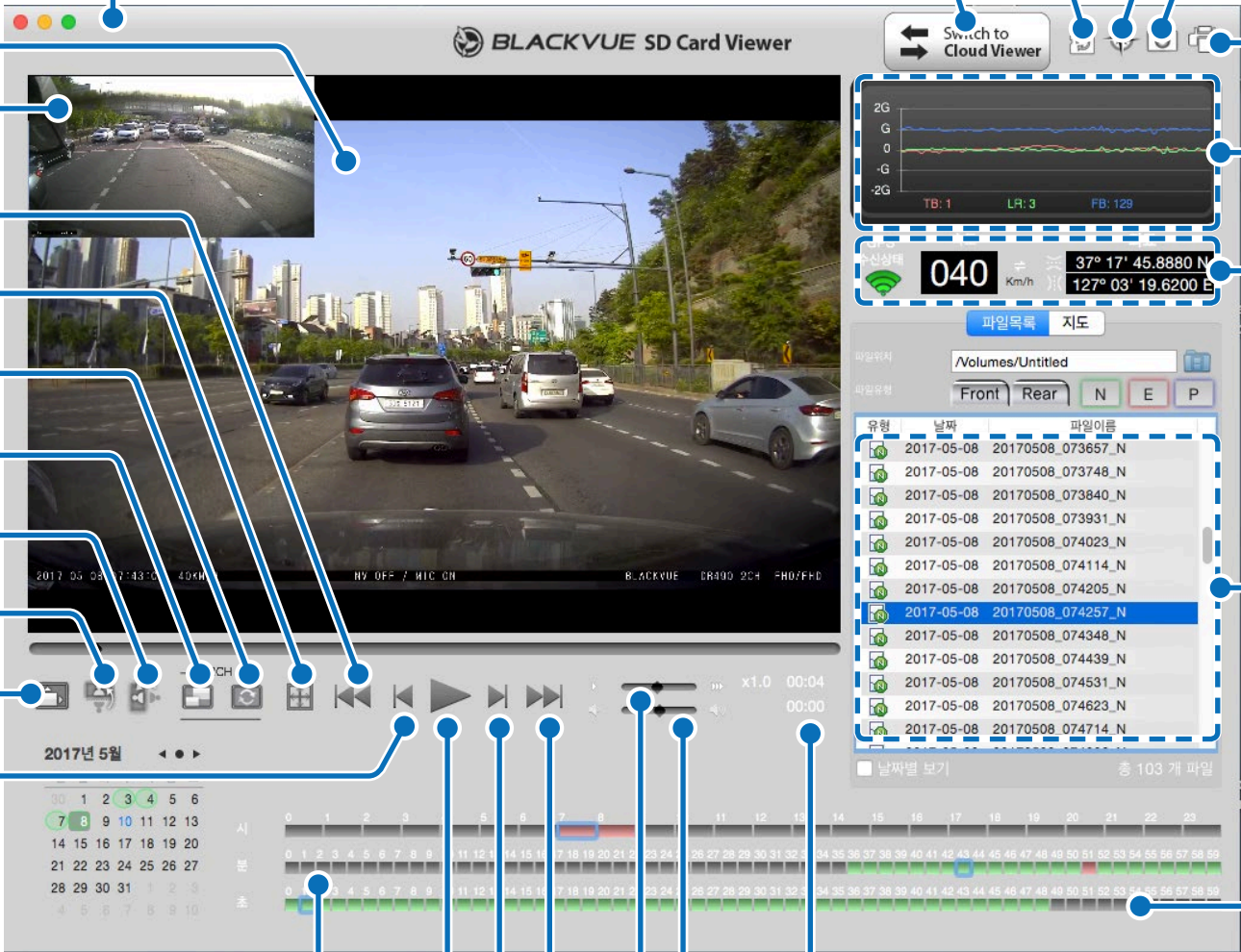

The screenshot shows the main interface of the BLACKVUE SD Card Viewer. The central area displays a video playback from the front camera. To the right, there is a sidebar with several panels: G-Sensor Information (showing a graph), GPS Data (showing speed, altitude, and coordinates), and a Recorded File List (a table of files). At the bottom, there is a playback control bar with a timeline, play/pause buttons, and volume control. A smaller window titled 'MyWay Viewer' is shown in the top right corner, displaying a map with a route.

Labels and their corresponding components:

- Settings
- Format
- Switch between SD card Viewer and Cloud Viewer
- MyWay Viewer
- Capture
- Print
- Playback Screen (front camera)
- Playback Screen (rear camera)
- Play previous file
- Normal screen size
- Front/Rear reverse view
- Front/Rear screen mode
- Flip horizontally
- View upside-down
- Full Screen view
- Previous frame
- G-Sensor Information
- GPS Data
- Recorded File List
- Timeline for min selection
- Playback/Pause
- Next frame
- Play next file
- Volume control
- Playback speed control
- Playback time
- Timeline for sec selection



















Playing video

Playing back videos



In BlackVue Viewer double click a video file to play.



BlackVue Viewer shows by default the files in the microSD card. To see files in another folder click the  button and browse to the folder.

Identify video files by recording type

		20171020_104013_EF	
		20171020_104013_ER	
		20171020_104002_NF	
		20171020_104002_NR	
		20171020_103902_NF	
		20171020_103902_NR	

- **Recording type:** N: Normal
E: Event
P: Parking mode motion detection
- **Camera direction:** F: Front camera
R: Rear camera
- **Example file name:** 20170104_150838_NF.mp4
Date & time: 4th January 2017, 03:08:38 PM
Recording type: Normal
Camera direction: Front camera

- Use the   **N** **E** **P** buttons to filter the video list by recording type. The **E** filter button displays both E(Event) and I (Impact event while parked) recordings..

	Normal	The dashcam records in normal mode by default.
	Event	When the dashcam detects an impact while in normal or parking mode, it switches to event mode and saves an event recording beginning 10 seconds before the event trigger.
	Parking	In parking mode the dashcam continuously buffers video. When motion is detected in the dashcam's field of view, it saves a parking recording beginning 10 seconds before the motion detection.

The car icon with an arrow pointing to the right indicates a front dashcam recording.

The car icon with an arrow pointing to the left indicates a rear dashcam recording.

 **Note**

- The dashcam requires a constant power source to record in parking mode. See "**Optional accessories**" on page 79 for more information.

☐ Checking the displayed time

The time the video was recorded is displayed in the lower left corner of the video in the playback screen. If the displayed time in the recorded videos is incorrect please see **"Time"** on page 70 or 77.

☐ Using BlackVue Viewer

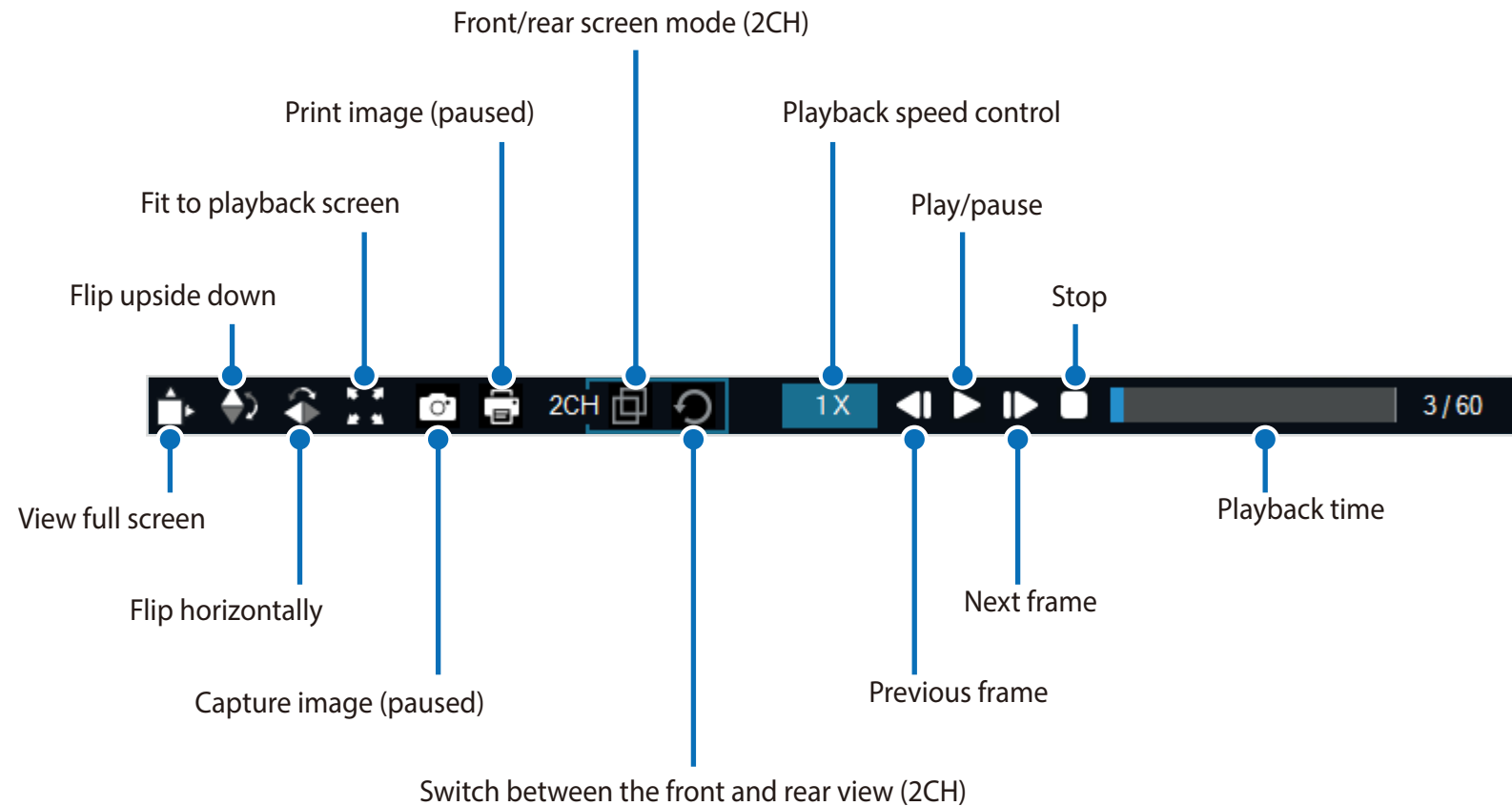

❑ Exploring the timeline and G-Sensor graph

You can explore the timeline for the playback of the recorded videos by date, hour, minute and second using the timeline.

You can check the impact sensitivity (G-Sensor) information in the line graph.

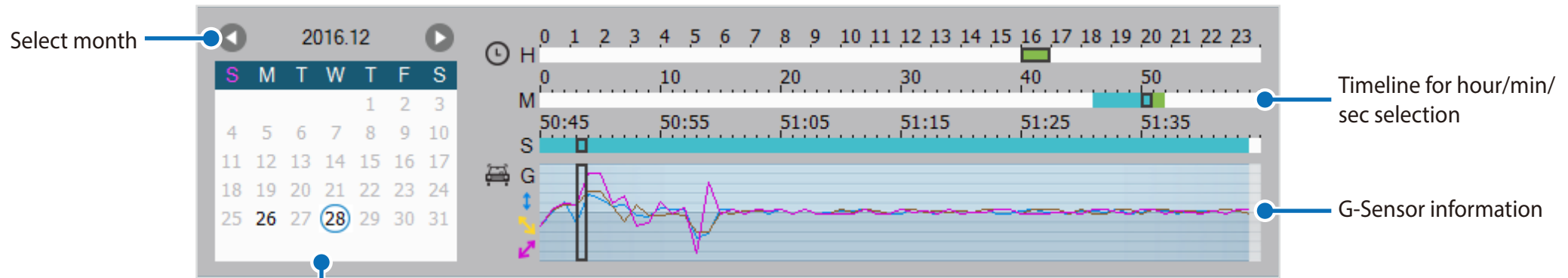

- Select date
- Dates with recordings are black
 - Click a date to filter recordings (date changes to red and circled)

Zoom options

- Use the mouse scroll wheel zoom. Right clicking will restore the video to the default size.
- You can resize the playback frame or the BlackVue Viewer window by dragging the borders.
- **Full-screen view:** Double click on the video image to enter full-screen view. Double click again or tap ESC to return to the default view.

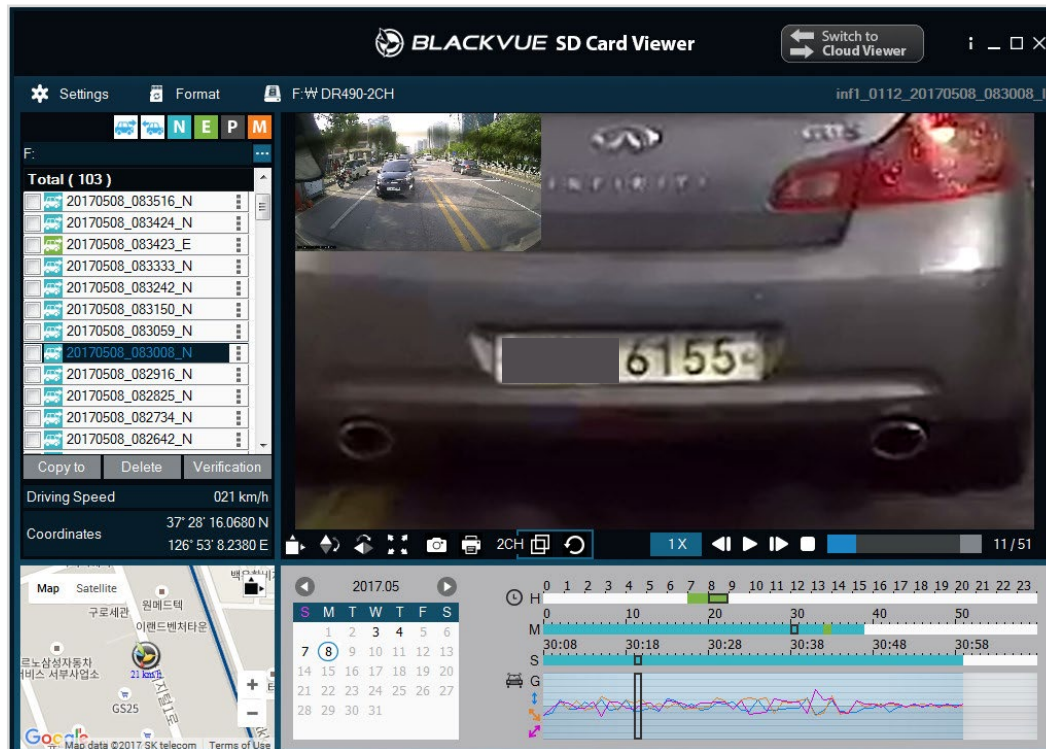

Windows

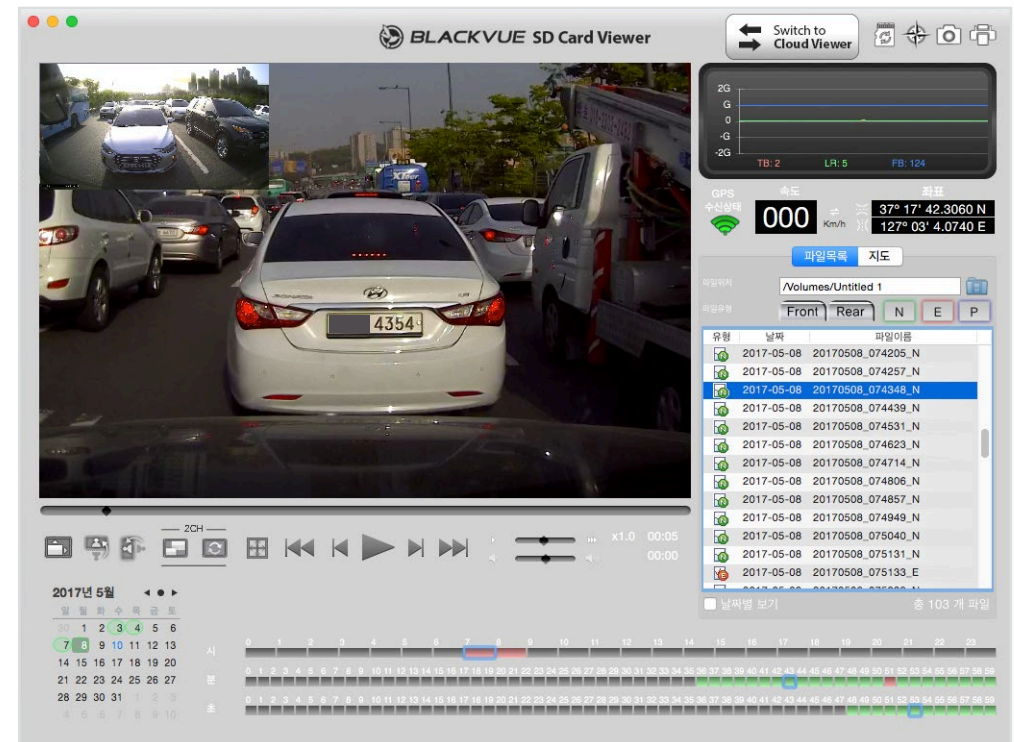

Mac

☐ Checking the GPS data

You can check the GPS data of the recorded video in BlackVue Viewer while video is playing back. The driving speed and coordinates are displayed above the map frame.

📝 Note

- GPS data is not recorded during parking mode. Map data cannot be displayed for parking mode recordings.
- The external GPS receiver is required to obtain GPS data.

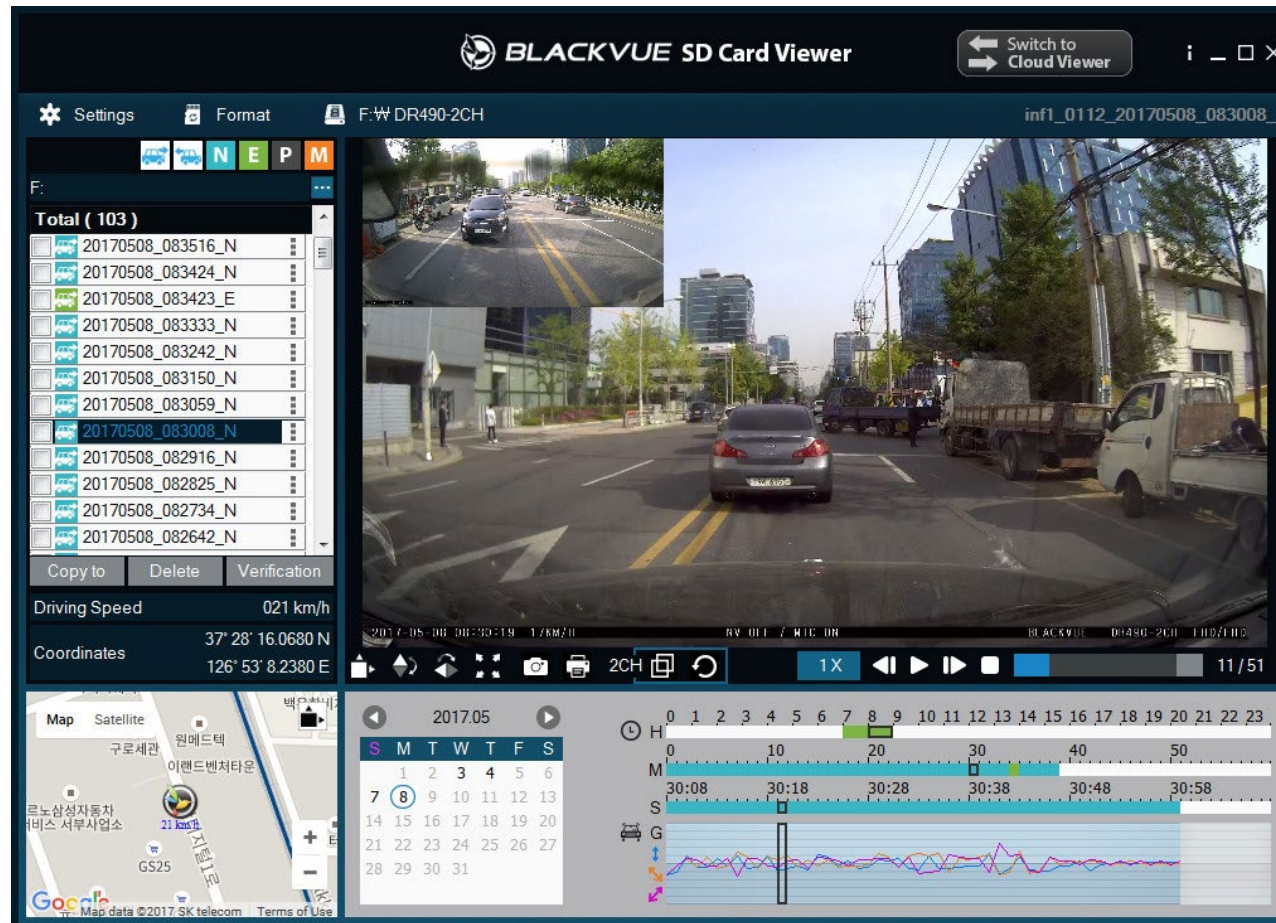



Managing videos

You can manage the recorded videos through the BlackVue Viewer program. You can also format the microSD card.

Note

- If the microSD card is full, by default the dashcam will record over the oldest videos first.

Capturing or printing a still image from video

- 1 Double click a file in the file list to play.
- 2 Click the  pause button to pause the video.
- 3 Select the  capture button to capture the image or the  print button to print directly.

Deleting videos

For Windows users

- 1 Select the video, or videos using the checkboxes, from the recorded video list.
- 2 Click **Delete**.
 - You can also delete individual files by clicking  next to a video in the recorded video list and selecting **Delete**.

■ For Mac users

- 1 Go to \BlackVue\Record\.
- 2 Select the video from the recorded video list.
- 3 Click Move to Trash.

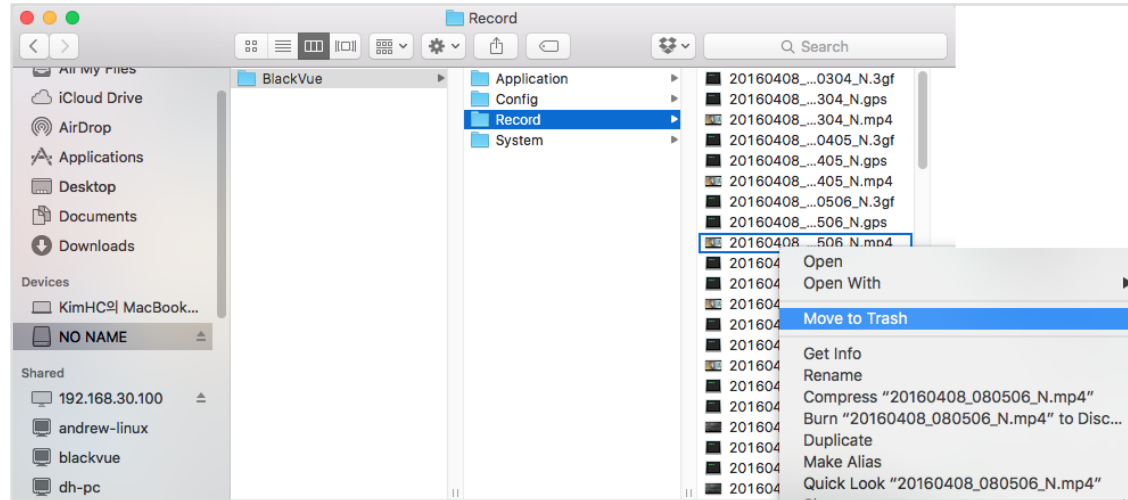

Exporting videos

For Windows users

1 Click  next to a video in the recorded video list.

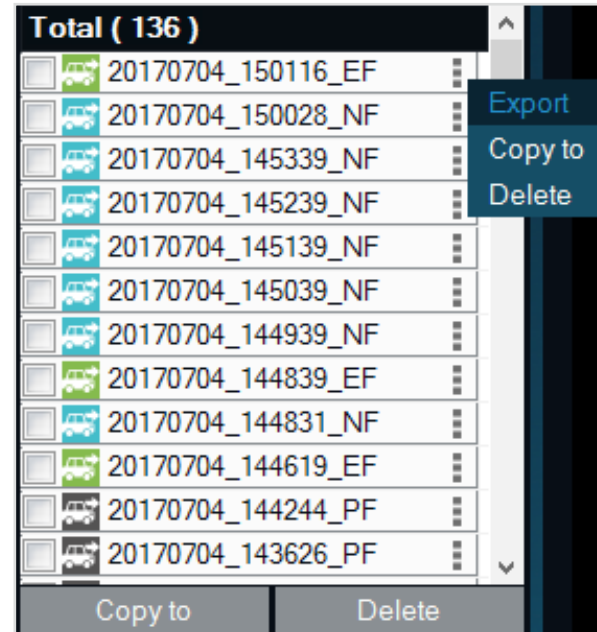

2 Click **Export**.

3 If you want to extract a segment of a file select **Save segment** and edit the start and end second points. To export without audio select **Sound Off**.

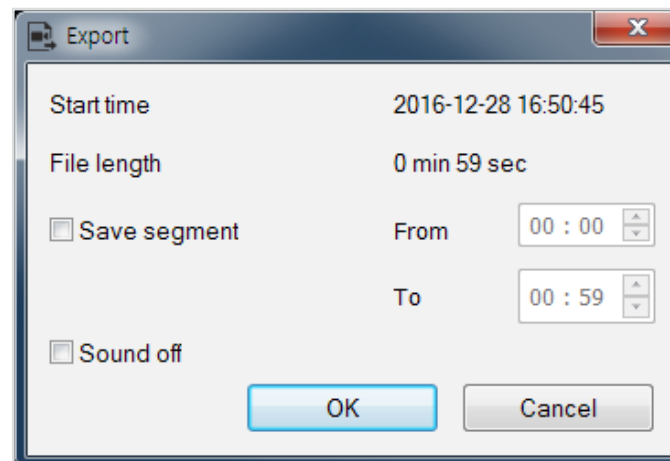

- 4 Click the **OK** button.
- 5 Select the folder in which to save the file and enter the file name.
- 6 Click the **Save** button.

Copying videos

For Windows users

- 1 Click  next to a video in the recorded video list.
- 2 Click **Copy to**.
- 3 Select the folder in which to copy the file and enter the file name.
- 4 Click the **Select folder** button.
 - To copy multiple files at once check the boxes next to the file names and press the **Copy to** button
 - When copying files the segment adjustment and sound off tools are not available.

■ For Mac users

- 1 Go to \BlackVue\Record\.
- 2 Select the video from the recorded video list.
- 3 Click Copy "*file name*".

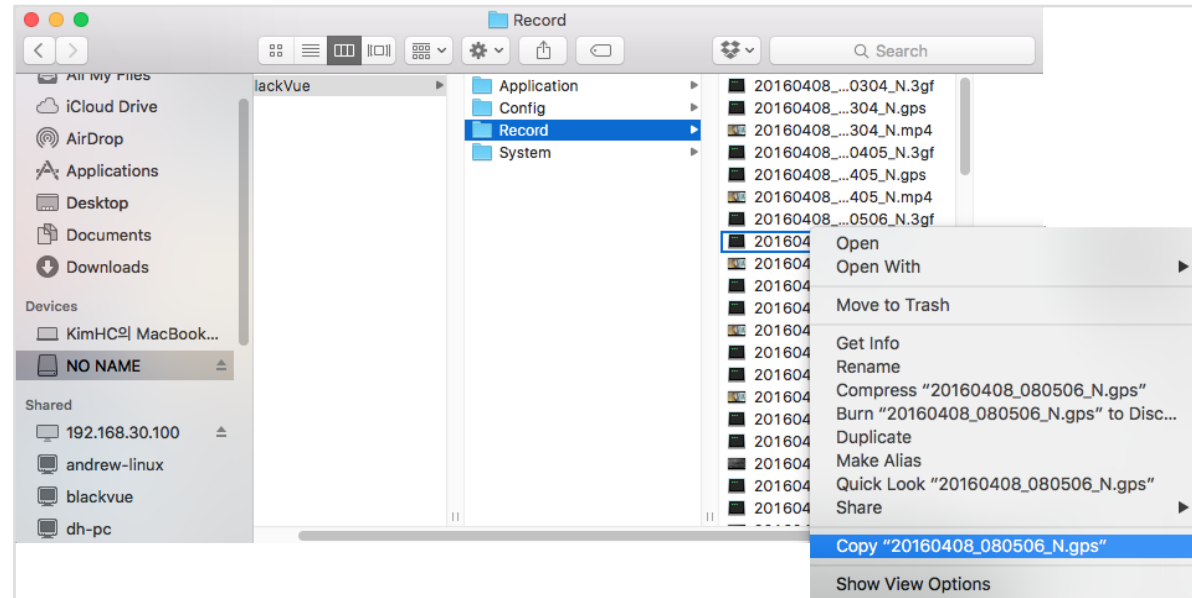

▶ Formatting the microSD card

⚠ Caution

- Back up important video files such as event recording files before formatting the microSD card. If you format the microSD card, all the video files stored in the microSD card will be deleted. Your saved settings will not be affected.

➤ Formatting the card in the BlackVue

To format the microSD card press the Wi-Fi / Format Button for 10 seconds until the dashcam beeps.

➤ Format using BlackVue Viewer (Windows)

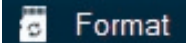
- 1 Insert the microSD card into the microSD card reader and connect the reader to your computer.
- 2 Download **BlackVue Viewer (Windows)** from www.blackvue.com > **Support** > **Downloads** and install it on your computer.
- 3 Launch the **BlackVue Viewer** that is installed on your computer.
- 4 Click the  **Format** button, select the card drive and click OK.

➤ Format using BlackVue Viewer (macOS)

- 1 Insert the microSD card into the microSD card reader and connect the reader to your computer.
- 2 Download **BlackVue Viewer (Mac)** from www.blackvue.com > **Support** > **Downloads** and install it on your computer.
- 3 Launch the **BlackVue Viewer** that is installed on your computer.
- 4 Click the  Format button and select the microSD card from the list of drives in the left frame.

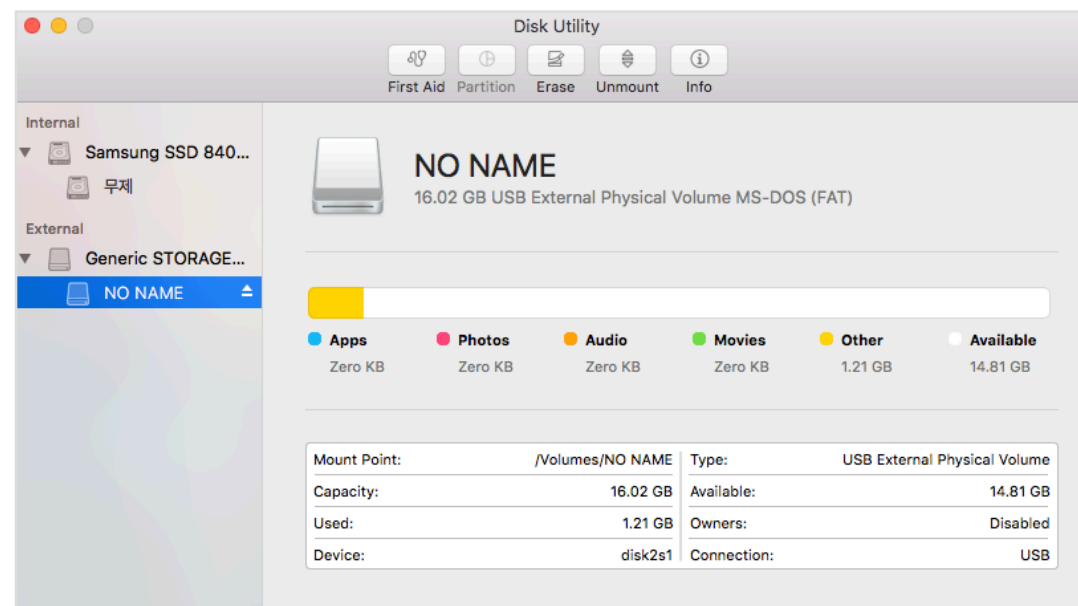

- 5 After selecting your microSD card select the Erase tab in the main window.

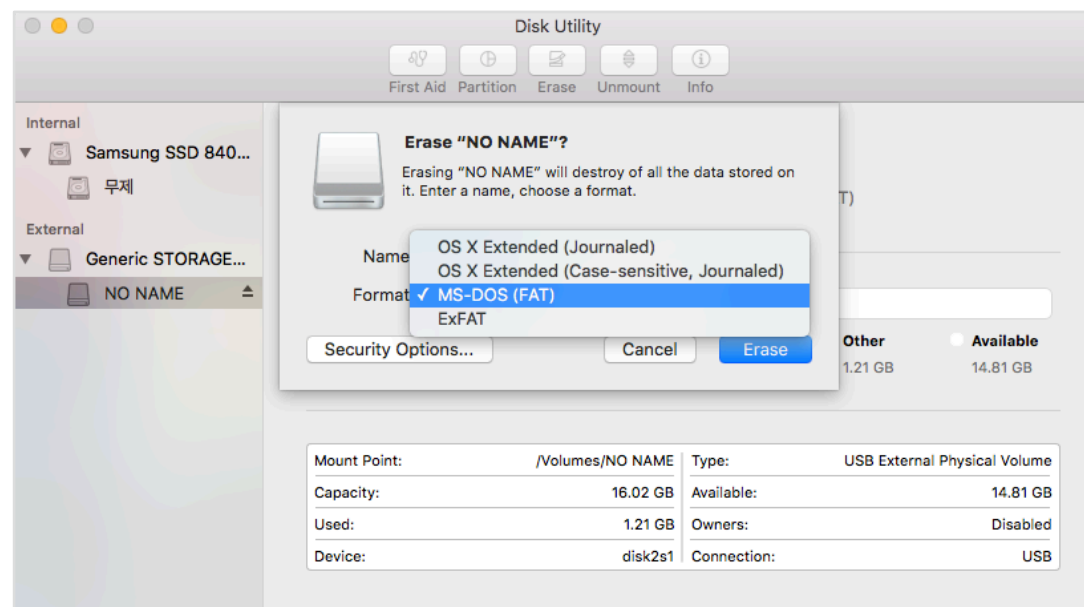

- 6 Select "MS-DOS (FAT)" from the Volume Format drop-down menu and click Erase.

Note

- Formatting the microSD card once a month is recommended.
- Format the microSD card if the recorded video quality appears to be poor.
- Only use official BlackVue microSD cards. Other cards may have compatibility issues. PittaSoft Co., Ltd. will not be held responsible for any problems caused by using another manufacturer's microSD card.
- For Windows users: To format the microSD card directly from "My Computer", right-click the microSD card drive and select Format. Select File system as FAT32 and Allocation unit size as 64KB then click Start. If FAT32 is not available or can't be selected, please format the microSD card using BlackVue Viewer.

Upgrading the firmware

Regularly upgrade the firmware for performance improvements and updated features. Firmware updates will be made available for download at www.blackvue.com > **Support** > **Downloads**.

Your saved settings are not affected by firmware upgrade.

Upgrading the firmware using an iOS or Android device (Firmware Over The Air)

[Click here for a step-by-step video tutorial](#), or go to the main menu and select **Help** > **Video tutorials**.

Makes sure your smartphone has a stable internet connection.

- 1 Open the BlackVue app
- 2 Tap  and select **Firmware download**.
- 3 Select your dashcam model and the firmware language and tap **OK**.

Note

- Please select the firmware language currently installed in your dashcam. Once upgrade is completed, you can change the firmware language from dashcam settings as described on page **66** or **69**.

- 4 Check the firmware version and release notes and tap **OK** to start downloading.
- 5 After the download completes tap **OK** to be taken back to the home screen.

Make sure your BlackVue dashcam is on and nearby.

6 Go to your smartphone's **Settings** then select **Wi-Fi**, and make sure Wi-Fi is turned on.

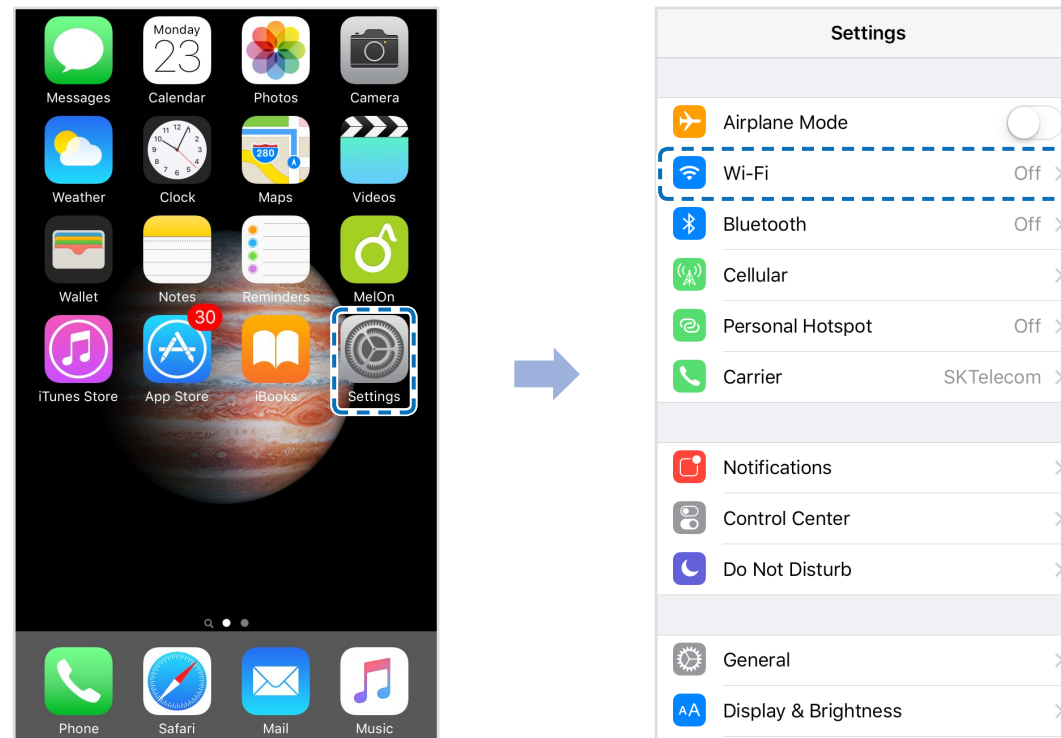

7 Choose your BlackVue dashcam from the network list. The dashcam's default SSID begins with its model number (e.g. BlackVue****_*****).

8 Enter the password and tap join.

* The default Wi-Fi SSID and password are labeled on the dashcam. To find them, unplug the cables and remove the front camera from its mount.

9 Open the BlackVue app. Select **BLACKVUE WI-FI** >  > **Firmware upgrade**.

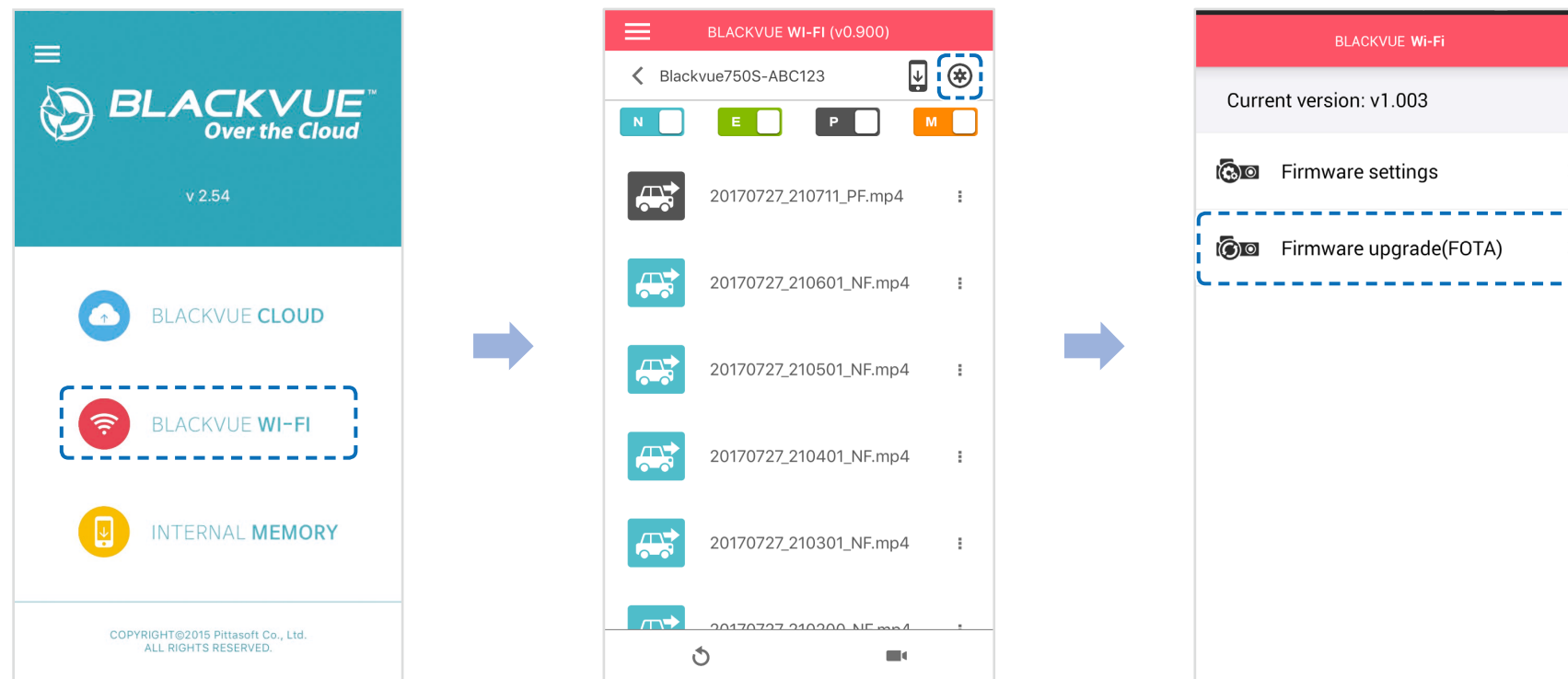

Note



- The firmware version currently installed on the microSD card is shown first. Below it, the firmware version you downloaded in step 4 is shown.

10 Tap **OK** to apply the firmware upgrade.

11 The dashcam's firmware will be upgraded – this may take a few minutes. The dashcam needs to reboot to complete the firmware upgrade.

Upgrading the firmware using a computer (Windows or Mac)

Keep your BlackVue dashcam updated by upgrading the firmware to the latest version. Visit the BlackVue website (www.blackvue.com) to check for any new firmware releases for your BlackVue dashcam model.

- 1 Insert the microSD card into the microSD card reader.
- 2 Connect the microSD card reader to a computer.
- 3 Launch BlackVue Viewer and click on the About  button.
 - For Mac users, click  **BlackVue Viewer** and select About BlackVue from the menu.

4 Check the current firmware version of your BlackVue dashcam and proceed only if your version is not the latest one.

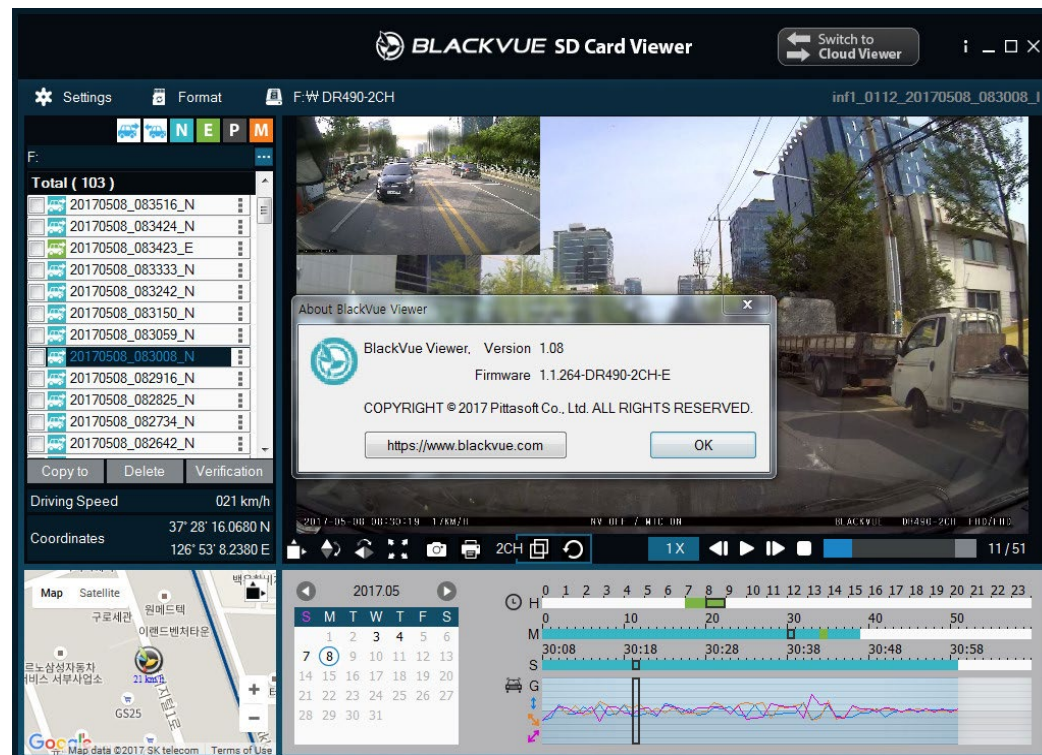

Windows

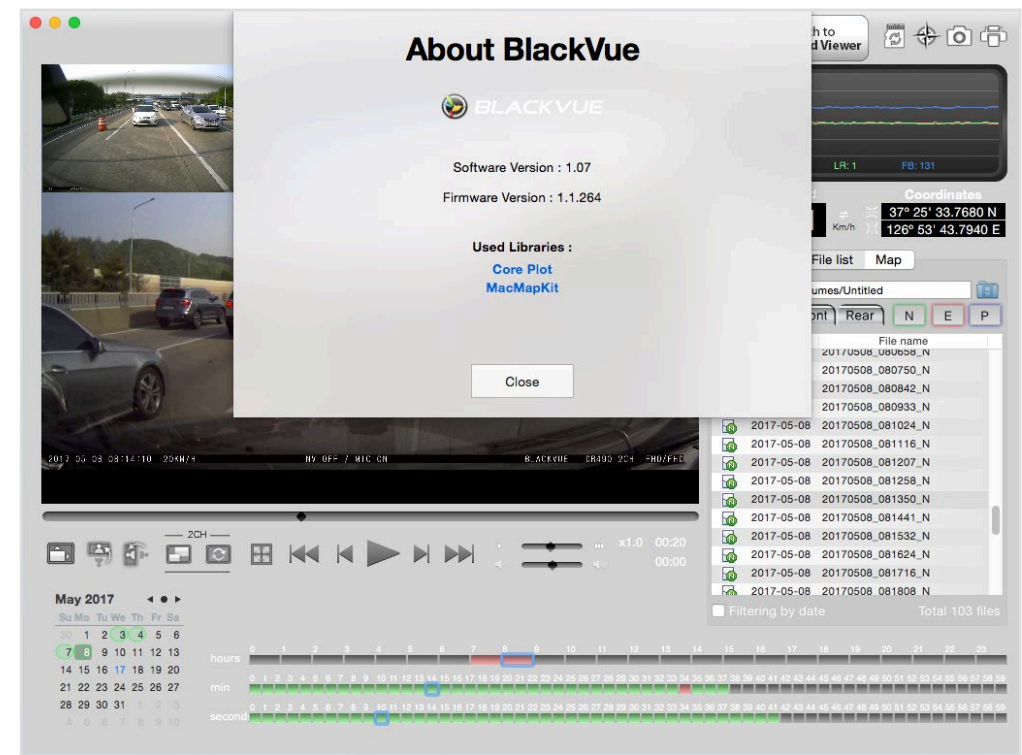

Mac

5 Format the microSD card. See **"Formatting the microSD card"** on page 43.

6 Go to the BlackVue website (www.blackvue.com > Support > Download) and download the latest firmware for your BlackVue dashcam model in zip format.

7 Unzip the downloaded file and copy the BlackVue folder to the microSD card.

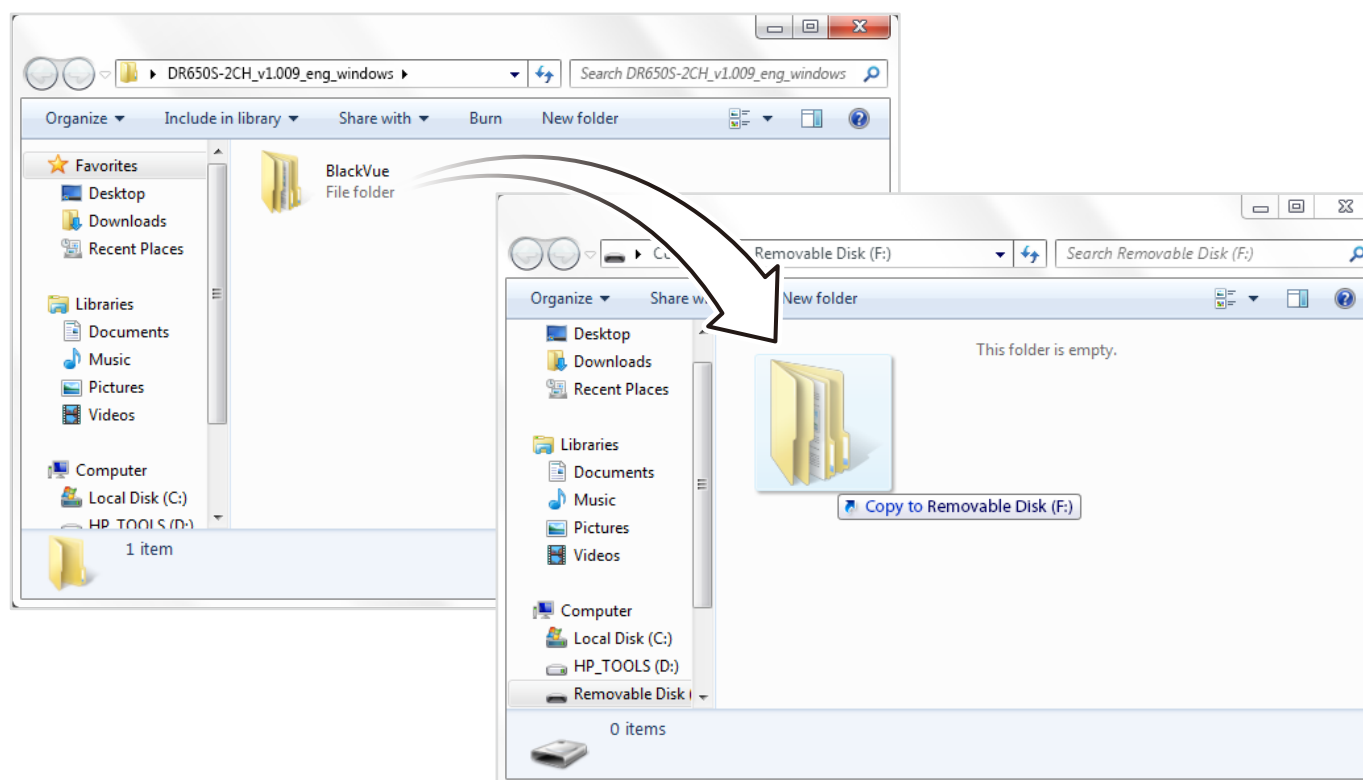

8 Insert the microSD card into the dashcam and connect the power to initiate the firmware upgrade. Make sure the power remains on until the upgrade is completed. Any power interruption may prevent the firmware upgrade from completing, resulting in malfunction.

Note

- Do not insert or remove the microSD card when the dashcam is turned on. Doing so may damage the data and cause a malfunction of the microSD card.
- Your saved settings are not affected by firmware upgrade.
- The firmware is upgraded to the previously saved language. You can change the language in firmware settings.

Changing settings

▶ Changing settings using your smartphone (Android/iOS)



“Pair” your smartphone with the BlackVue dashcam via direct Wi-Fi (for details see **"Opening video files" on page 17**).

- 1 Go to your smartphone's **Settings > Wi-Fi** and connect to your dashcam.
- 2 Open the BlackVue app. Select **BLACKVUE WI-FI > ⚙️** to access the Firmware settings menu.
- 3 After making any changes, go back to the Firmware settings menu, tap **<** and tap **Save and close**.

⚠️ **Caution**

- Please backup necessary recordings before changing **time, video resolution, image quality** or **video segment length** settings. If any of the aforementioned settings are changed and saved, the dashcam will format the microSD card and delete all recordings stored on the card including locked event files in order to ensure optimal performance.

Basic settings

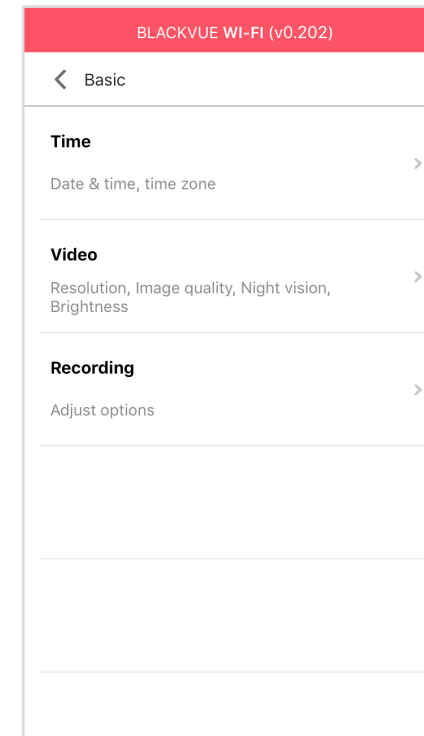
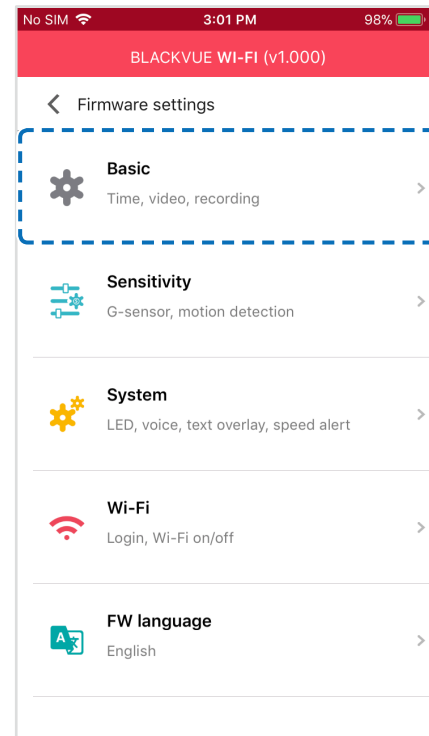

Time settings

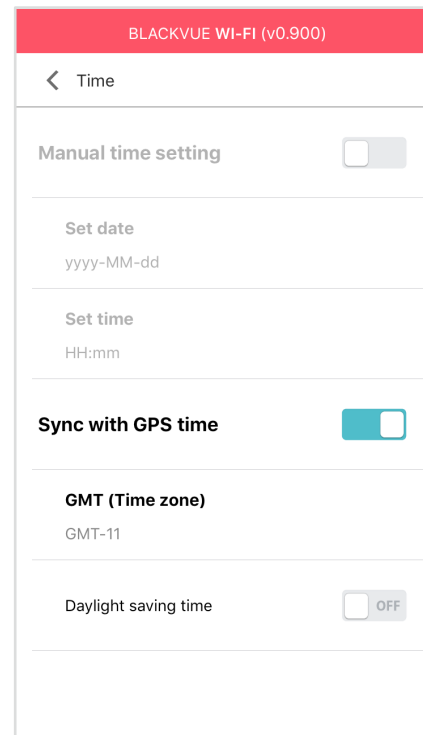

If you do not connect the GPS receiver:

To manually set the time select **Manual time setting** and set your data and time.

When setting the time manually, please set to the expected time you will use the BlackVue(not the present time).

If you connect the GPS receiver:

If you run the dashcam with the GPS receiver connected, it is possible to sync with GPS time. To sync with GPS time, select your GMT time zone. The factory setting is GMT -11.

Some examples of GMT time offsets are:

- GMT-7: Los Angeles
- GMT-4: New York
- GMT+0: London
- GMT+1: Paris

- GMT+3: Moscow
- GMT+8: Singapore
- GMT+9: Seoul
- GMT+10: Sydney

If you are unsure of your GMT offset please look up your city on <https://greenwichmeantime.com/>

* Selecting **Daylight saving time** will advance the clock by one hour.

Video settings

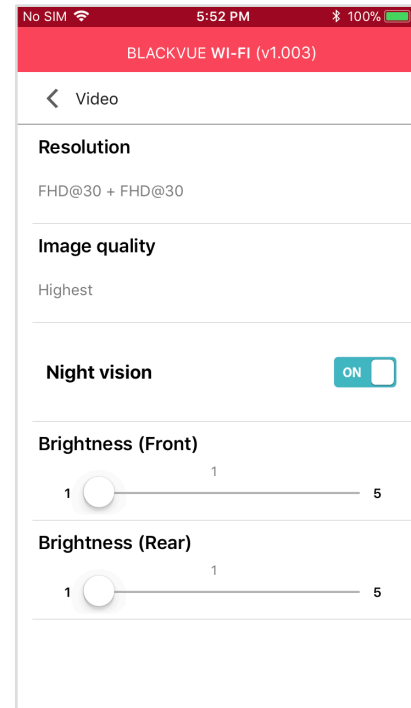

Resolution

Select the resolution and frame rate. For example, "FHD@30 + FHD@30" means the front camera records Full HD video at 30 frames per second, and the rear camera records Full HD video at 30 frames per second.

Note

- Frame rate may vary during Wi-Fi streaming.

Image quality

You can adjust the recording image quality (bit rate). Choose between:

- Highest (Front: 12 Mbit/s, Rear: 10 Mbit/s)
- High (Front: 10 Mbit/s, Rear: 8 Mbit/s)
- Normal (Front: 8 Mbit/s, Rear: 6 Mbit/s)

These are the maximum bit rates when the resolution is set to "FHD@30 + FHD@30". If you lower the resolution setting, the actual bit rates will be lower.

Increasing the image quality will increase the size of the video files. Loading and copying time will increase accordingly.

■ **Night vision**

Turning on night vision will brighten the image when recording in low-light environments.

■ **Brightness (Front)**

You can adjust the recording brightness level of the front camera.

■ **Brightness (Rear)**

You can adjust the recording brightness level of the rear camera.

Recording settings

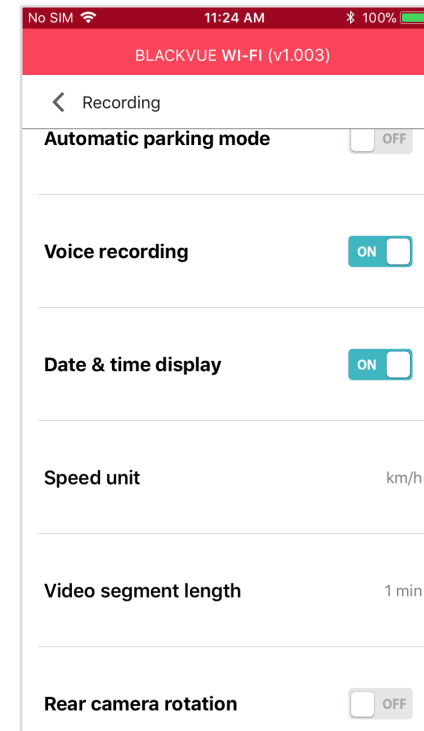
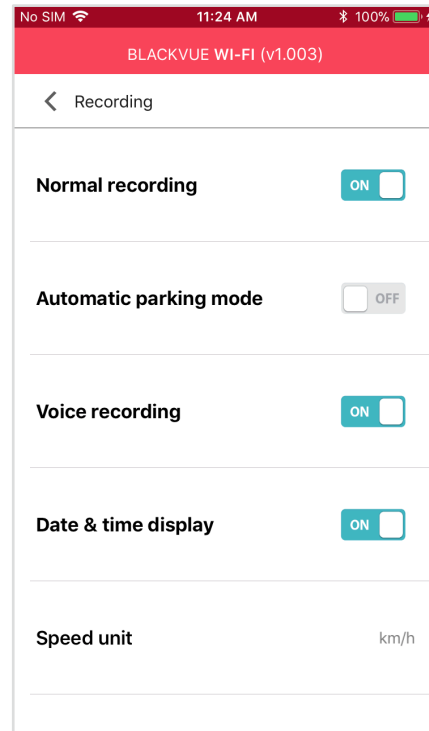

Normal recording

When turned off the dashcam does not record in normal mode.

Automatic parking mode

If enabled, the dashcam switches from normal mode to parking mode when the vehicle is stationary for 5 minutes.

Voice recording

When turned off the dashcam does not record audio.

■ **Date & time display**

Turn on/off the date and time display on videos.

■ **Speed unit**

Select km/h, MPH, or turn off.

■ **Video segment length**

Choose between 1, 2 or 3 minute video segment lengths.

■ **Rear camera rotation**

If you installed the rear camera in a flipped position, use this setting to rotate the rear camera image 180°.

Sensitivity settings

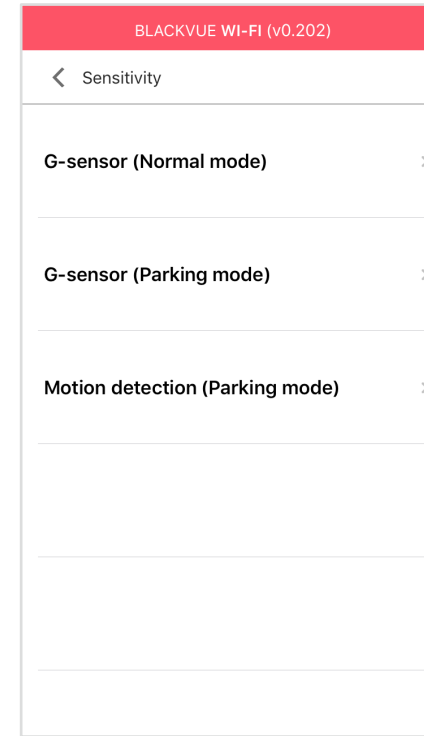
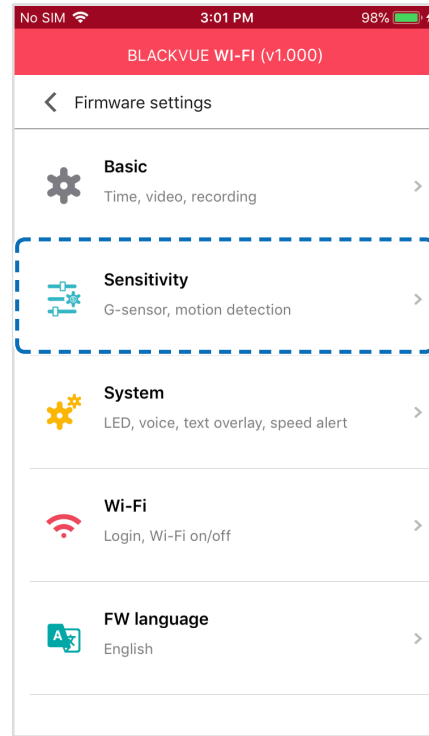

G-Sensor (Normal mode) / G-Sensor (Parking mode)

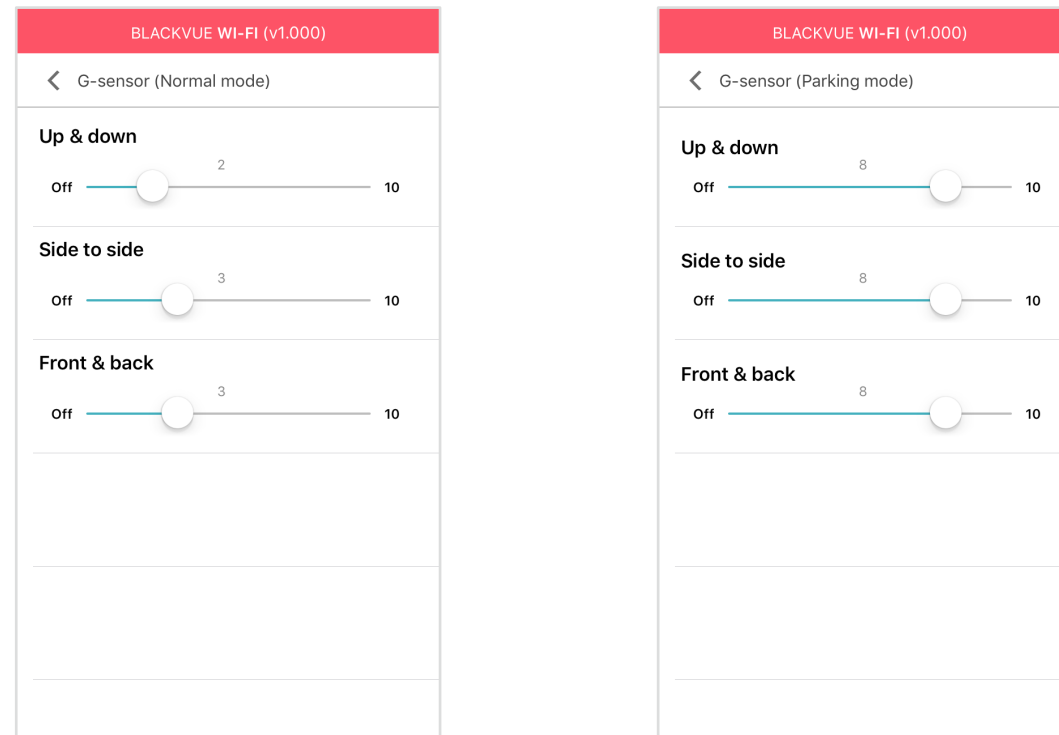

The G-sensor measures the movement of your vehicle through 3 axes – up and down, side to side, and front and back. When the G-sensor detects significant or sudden movement (such as an impact or collision) it will trigger an event recording. You can adjust the sensitivity so minor incidents and bumps don't trigger an event recording. To turn off event recordings by impact detection set the G-sensor sensitivity to off.

Motion detection (Parking mode)

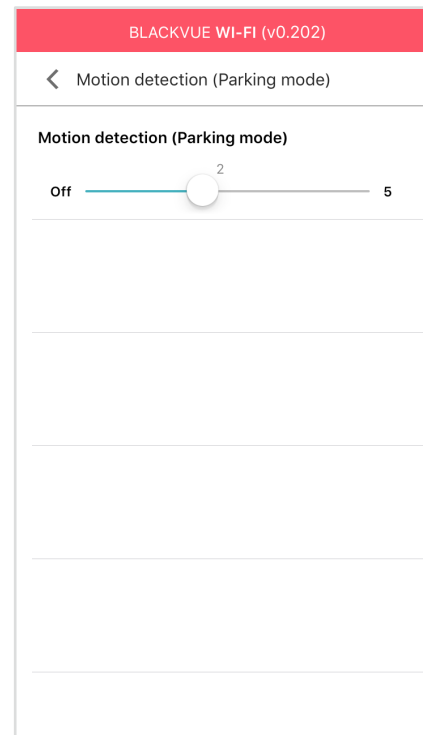

In parking mode the dashcam continuously buffers video and saves a parking recording when motion is detected in the dashcam's field of view.

You can adjust the sensitivity of the motion detection so minor motion caused by wind or rain doesn't trigger a recording. Please take into account your vehicle's surroundings when adjusting the sensitivity.

System settings

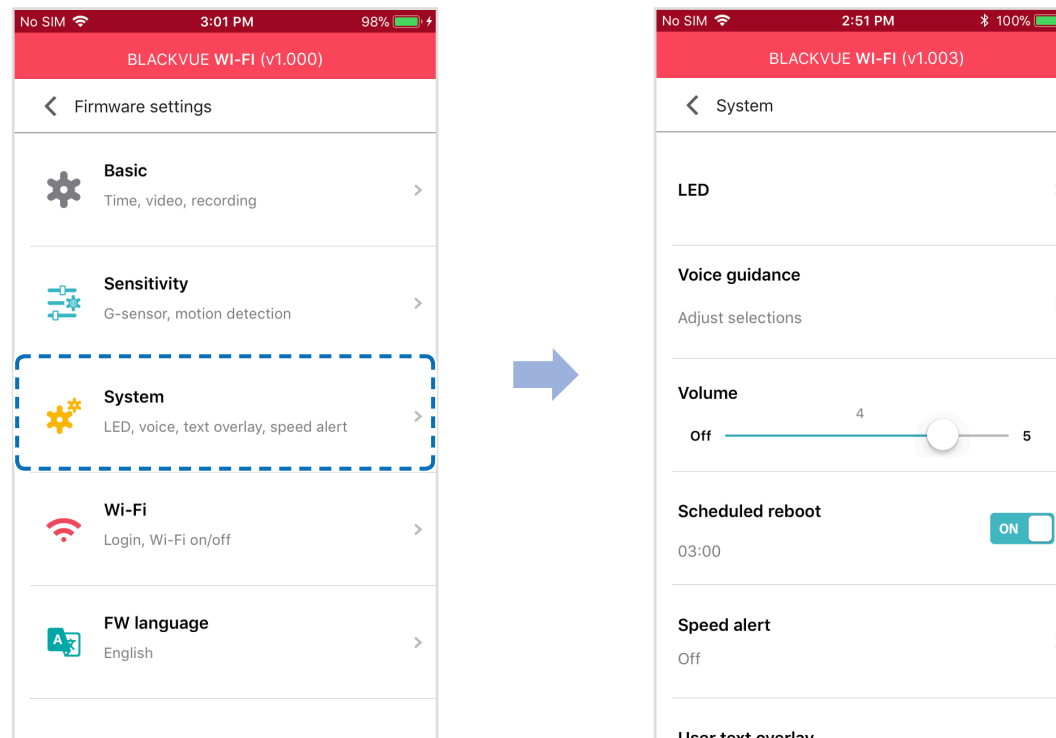

LED

Recording status

You can turn the recording status LED on/off.

Front security (Normal mode)

You can turn the front security LED on/off for normal mode.

Front security (Parking mode)

You can turn the front security LED on/off for parking mode.

Rear security

You can turn the rear security LED on/off.

Voice guidance

You can adjust the voice guidance (announcements) you want to hear.

Impact detected in parking mode

Notifies when exiting parking mode if an impact had been detected during parking mode, however, it ignores any impact detected within three minutes before exiting parking mode.

Volume

You can adjust the volume of the voice guidance (announcements).

Scheduled Reboot

The dashcam reboots automatically once-a-day if in parking mode at the set time for improved stability. If the dashcam is recording at the set time, the scheduled reboot is skipped.

You can enable/disable and change the time for scheduled rebooting. Default time is 03:00 am.

Speed alert

Set a speed limit (up to 300 km/h or 200 MPH) for the speed alert. When the vehicle exceeds the specified speed limit, the dashcam beeps and switches to event recording. After saving one event recording file the dashcam switches back to normal mode recording.

To make use of speed alerts an external GPS receiver must be connected to the dashcam.

User text overlay

You can create a user text overlay of up to 20 characters using a combination of English letters (A – Z, a – z), numbers (0 – 9), and symbols (;:/+_-()\$#). The text is overlaid in the top-left corner of the recorded videos.

➤ Wi-Fi settings

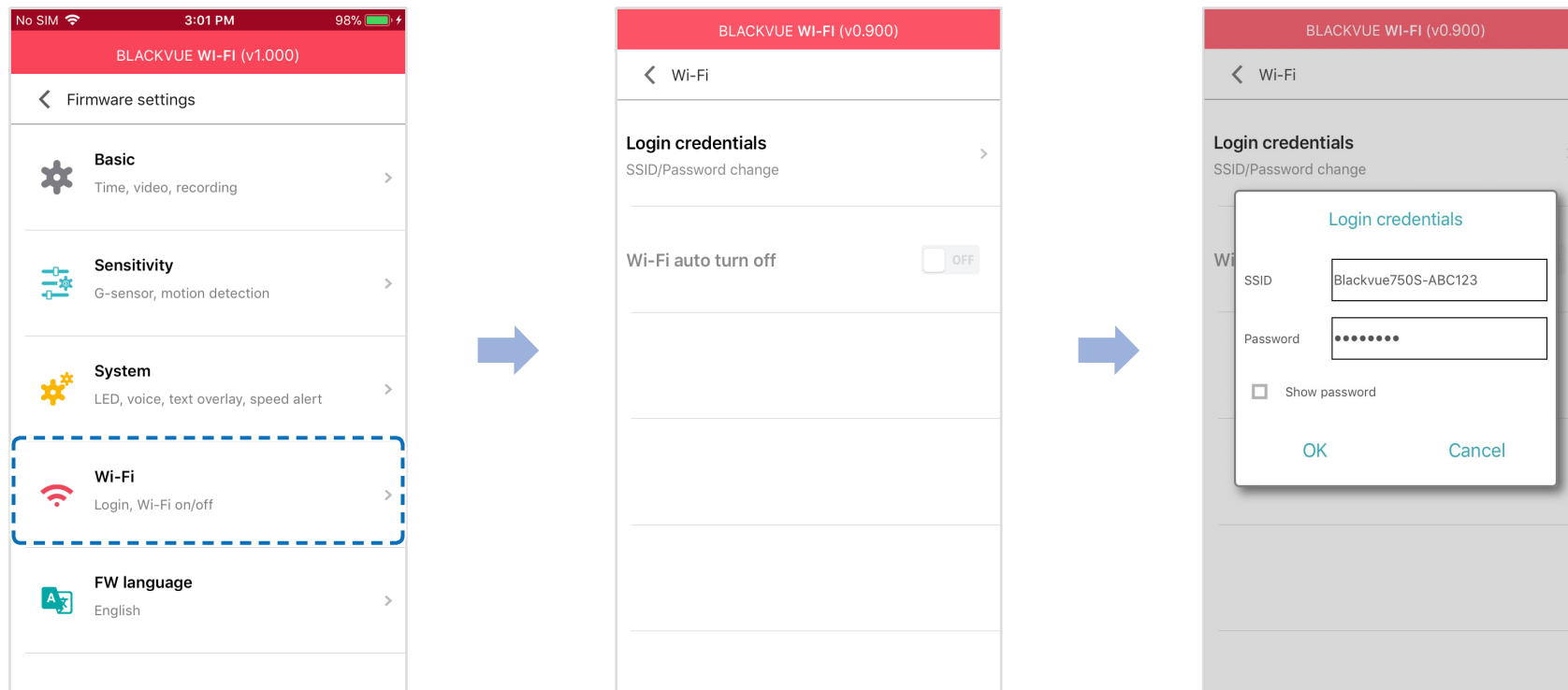

☐ Login credentials

You can change the dashcam's SSID and Wi-Fi login password.

☐ Wi-Fi auto turn off

When the Cloud service is enabled the Wi-Fi auto turn off setting cannot be adjusted. Wi-Fi will automatically switch on when you turn on the dashcam and remain on.

If you disable the Cloud service, you will be able to adjust the Wi-Fi auto turn off setting.

	ON	OFF
Wi-Fi auto turn off	Wi-Fi turns off if it is inactive for 10 minutes.	Wi-Fi does not turn off automatically.

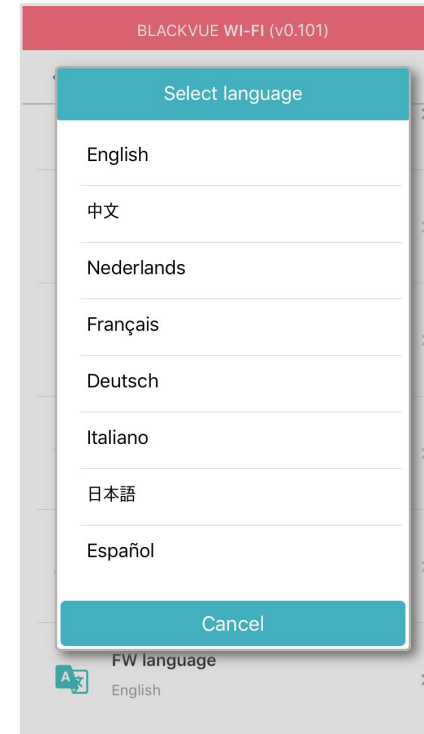
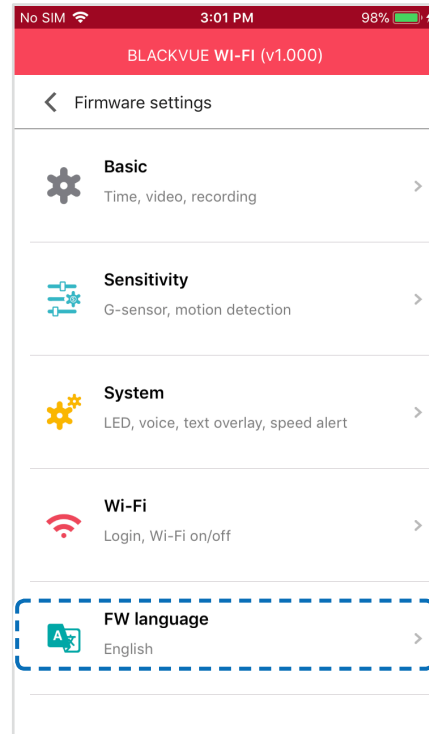

FW Language

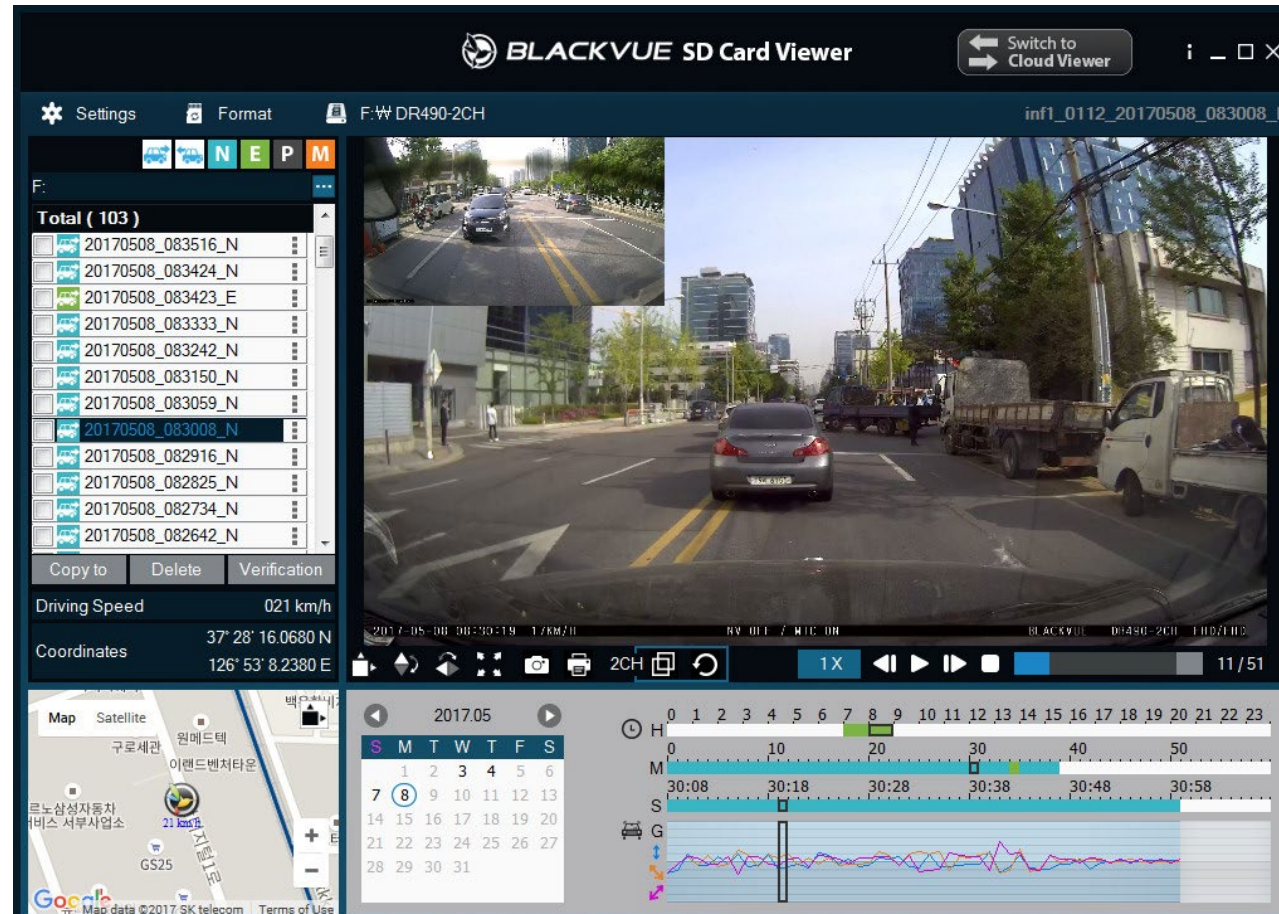

You can change the Firmware language of your dashcam.

▶ Changing settings using your computer (Windows/Mac)



Click on the  Settings button (Windows) or the  BlackVue Viewer menu (macOS) to open the BlackVue settings panel. You will be able to change most of the BlackVue settings to customize its operation.

BlackVue Viewer settings

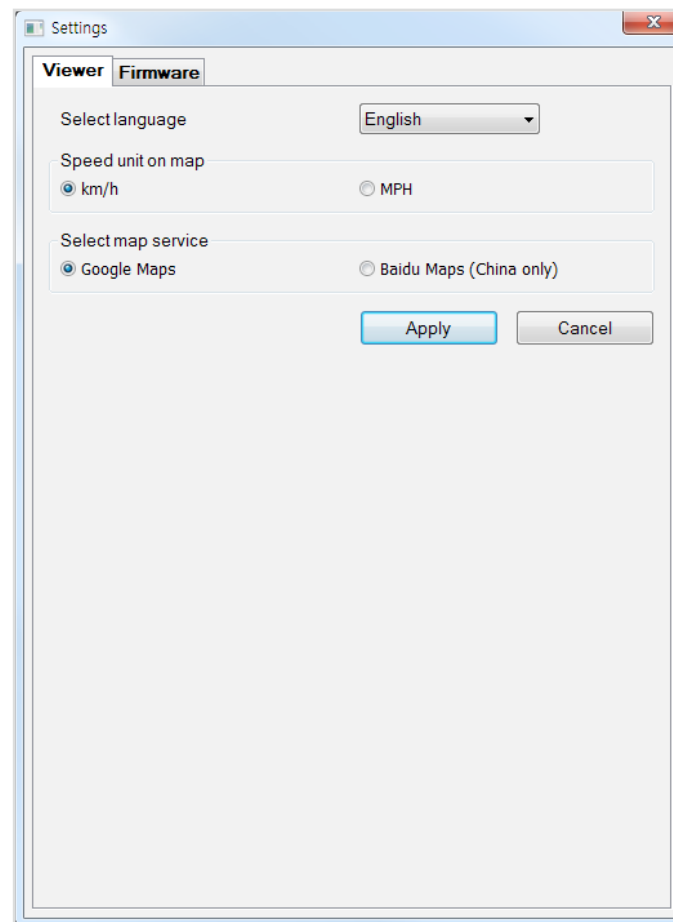

Select language

Select your preferred language for the BlackVue Viewer interface from the dropdown list.

Speed unit on map

Change the speed unit displayed on the map.

Select map service

Change the mapping service used.

Firmware settings

Select your preferred language for the firmware from the FW language dropdown list. The audio announcements by the dashcam will be in the selected language.

Caution

- Please backup necessary recordings before changing **time**, **video resolution**, **image quality** or **video segment length** settings. If any of the aforementioned settings are changed and saved, the dashcam will format the microSD card and delete all recordings stored on the card.

Basic settings

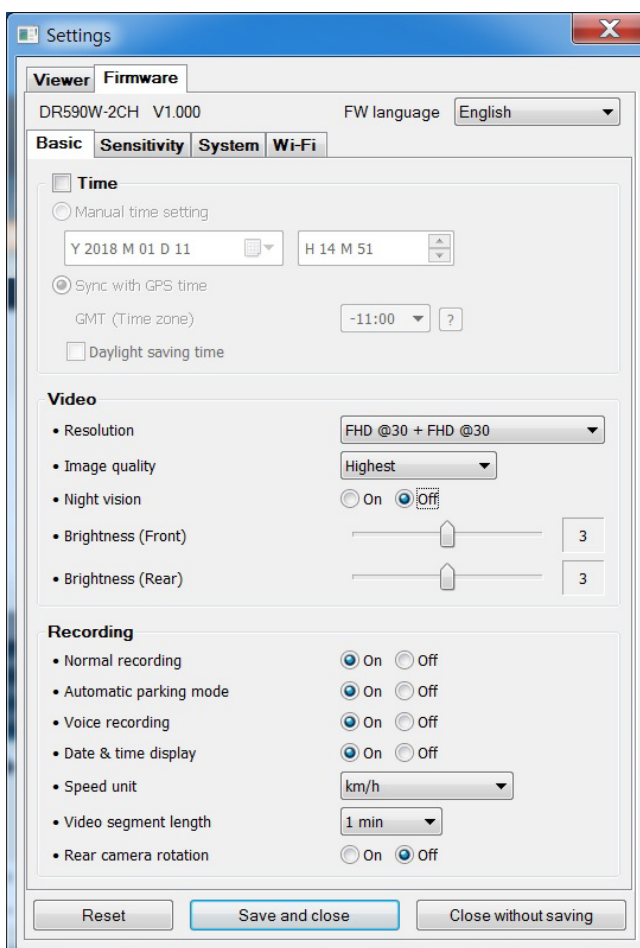

■ Time

If you do not connect the GPS receiver:

To manually set the time select **Manual time setting** and set your data and time.

When setting the time manually, please set to the expected time you will use the BlackVue(not the present time).

If you connect the GPS receiver:

If you run the dashcam with the GPS receiver connected, it is possible to sync with GPS time. To sync with GPS time, select your GMT time zone. The factory setting is GMT -11.

Some examples of GMT time offsets are:

- GMT-7: Los Angeles
- GMT-4: New York
- GMT+0: London
- GMT+1: Paris
- GMT+3: Moscow
- GMT+8: Singapore
- GMT+9: Seoul
- GMT+10: Sydney

If you are unsure of your GMT offset please look up your city on <https://greenwichmeantime.com/>

* Selecting **Daylight saving time** will advance the clock by one hour.

■ Video settings

– Resolution

Select the resolution and frame rate. For example, “FHD@30 + FHD@30” means the front camera records Full HD video at 30 frames per second, and the rear camera records Full HD video at 30 frames per second.

– Image quality

You can adjust the recording image quality (bit rate). Choose between:

- Highest (Front: 12 Mbit/s, Rear: 10 Mbit/s)
- High (Front: 10 Mbit/s, Rear: 8 Mbit/s)
- Normal (Front: 8 Mbit/s, Rear: 6 Mbit/s)

These are the maximum bit rates when the resolution is set to "FHD@30 + FHD@30". If you lower the resolution setting, the actual bit rates will be lower.

Increasing the image quality will increase the size of the video files. Loading and copying time will increase accordingly.

– Night vision

Turning on night vision will brighten the image when recording in low-light environments.

– Brightness (Front)

You can adjust the recording brightness level of the front camera.

– Brightness (Rear)

You can adjust the recording brightness level of the rear camera.

■ Recording settings

– Normal recording

When turned off the dashcam does not record in normal mode.

– Automatic parking mode

If enabled, the dashcam switches from normal mode to parking mode when the vehicle is stationary for 5 minutes.

– Voice recording

When turned off the dashcam does not record audio.

– Date & time display

Turn on/off the date and time display on videos.

- **Speed unit**

Select km/h, MPH, or turn off.

- **Video segment length**

Choose between 1, 2 or 3 minute video segment lengths.

- **Rear camera rotation**

If you installed the rear camera in a flipped position, use this setting to rotate the rear camera image 180°.

□ Sensitivity settings

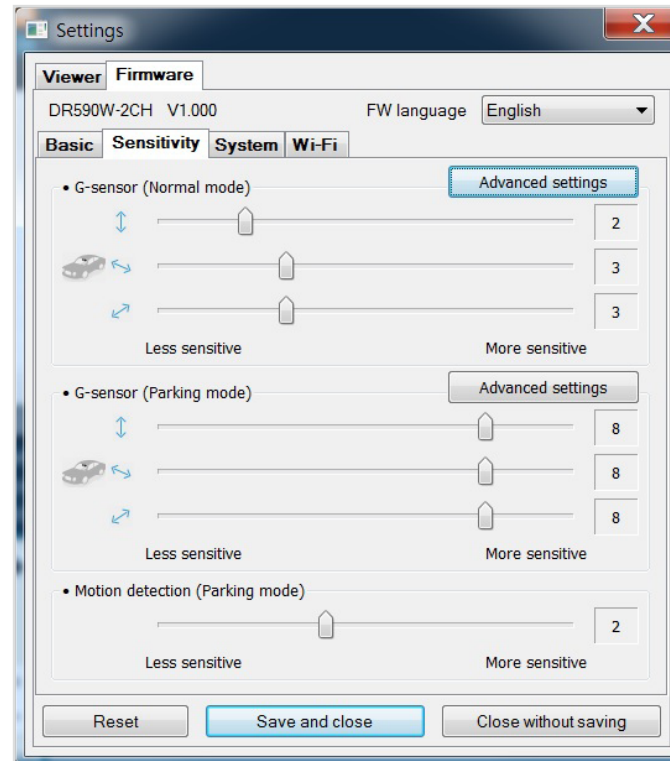

■ G-Sensor (Normal mode) / G-Sensor (Parking mode)

The G-sensor measures the movement of your vehicle through 3 axes – up and down, side to side, and front and back. When the G-sensor detects significant or sudden movement (such as an impact or collision) it will trigger an event recording. You can adjust the sensitivity so minor incidents and bumps don't trigger an event recording. To turn off event recordings by impact detection set the G-sensor sensitivity to off.

■ Motion detection (Parking mode)

In parking mode the dashcam continuously buffers video and saves a parking recording when motion is detected in the dashcam's field of view.

You can adjust the sensitivity of the motion detection so minor motion caused by wind or rain doesn't trigger a recording. Please take into account your vehicle's surroundings when adjusting the sensitivity.

■ Advanced sensitivity settings for normal and parking mode

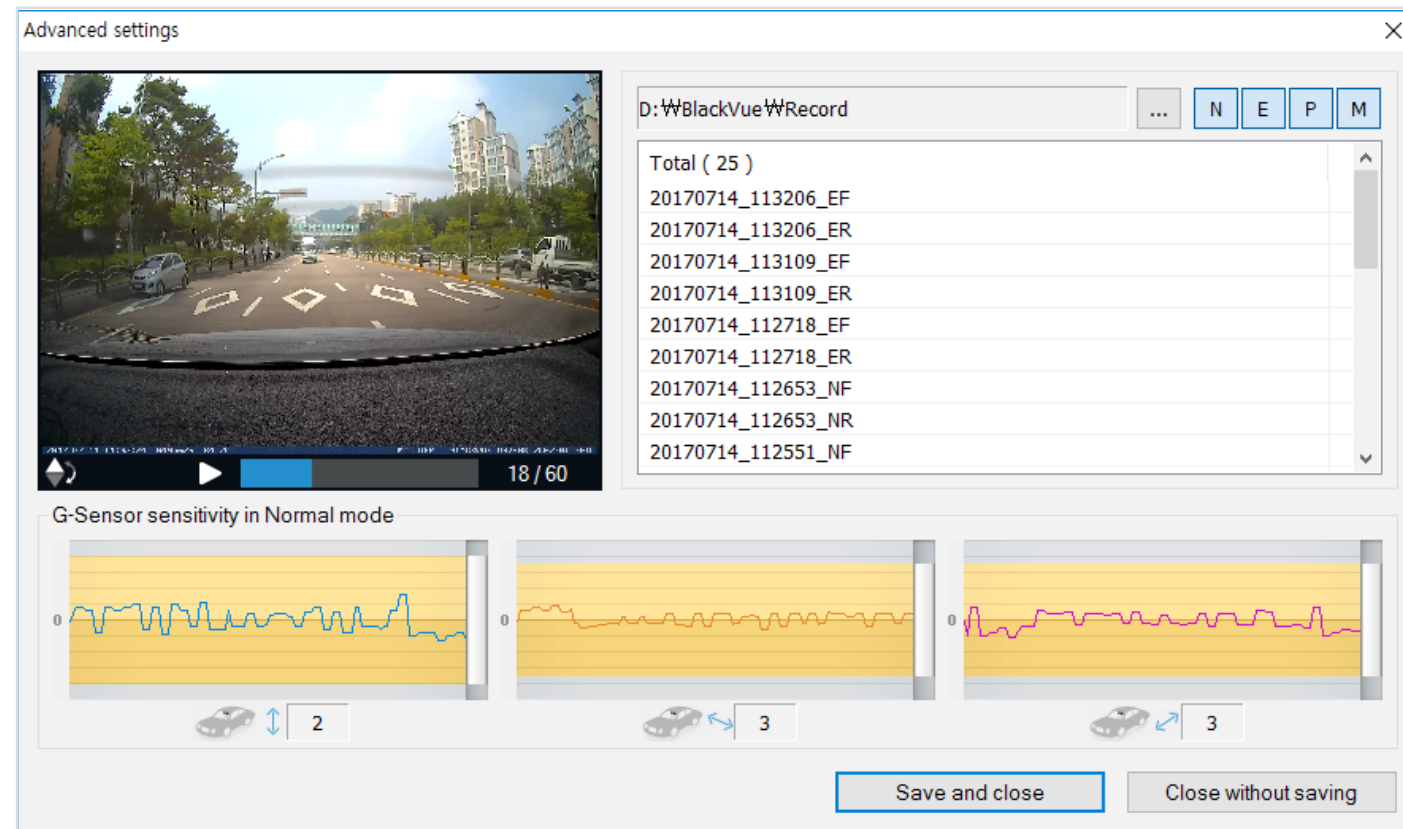

Advanced sensitivity settings allows you to fine-tune the event recording G-Sensor threshold, while watching pre-recorded G-Sensor data and video as a reference.

- 1 Click the **Advanced settings** button.
- 2 Double click the video from the list that you want to use as a G-Sensor data reference.
- 3 Set the thresholds by adjusting the control bars next to each G-Sensor axis. Any G-Sensor data that crosses over the threshold on any of the 3 axes will trigger an Event recording.

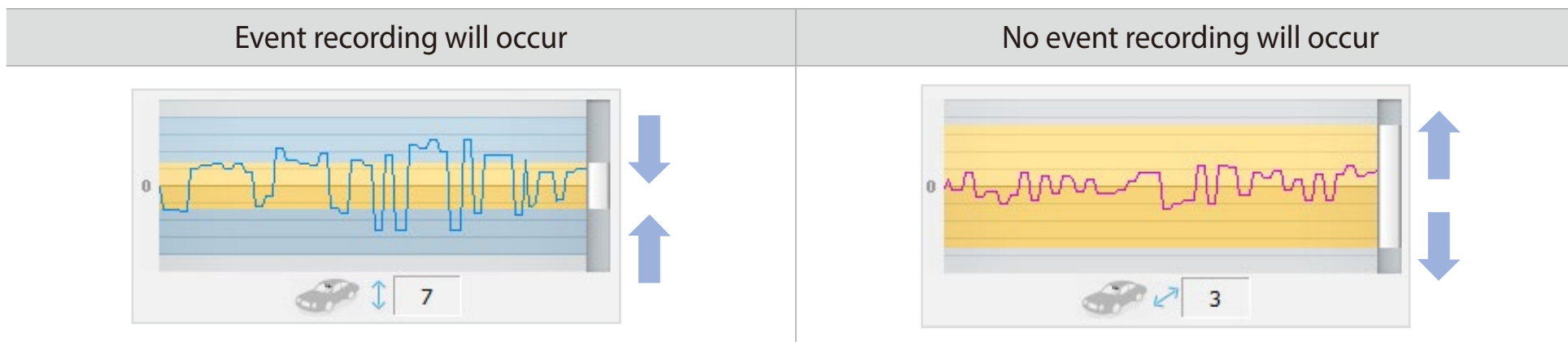

- 4 Click **Save and close**.

System settings

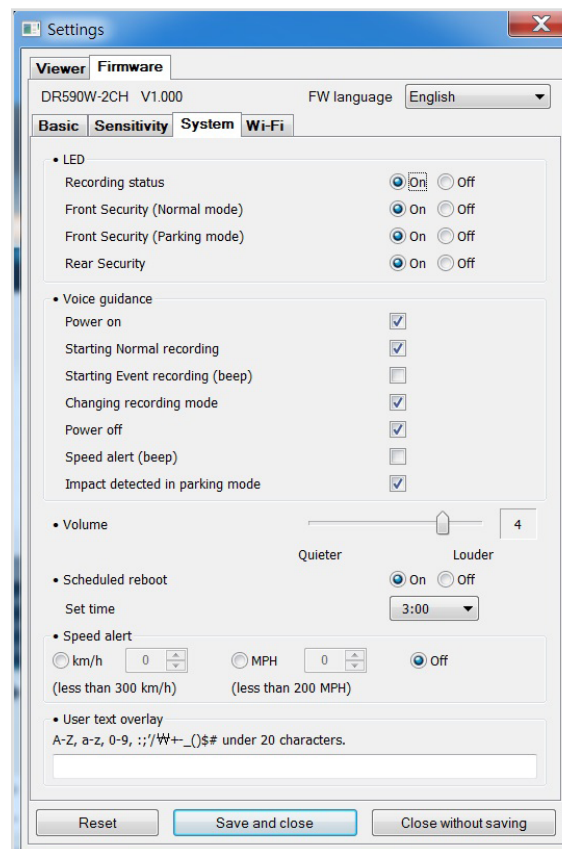

LED

– Recording status

You can turn the recording status LED on/off.

– Front security (Normal mode)

You can turn the front security LED on/off for normal mode.

– Front security (Parking mode)

You can turn the front security LED on/off for parking mode.

– Rear security

You can turn the rear security LED on/off.

■ Voice guidance

You can adjust the voice guidance (announcements) you want to hear.

– Impact detected in parking mode

Notifies when exiting parking mode if an impact had been detected during parking mode, however, it ignores any impact detected within three minutes before exiting parking mode.

■ Volume

You can adjust the volume of the voice guidance (announcements).

■ Scheduled Reboot

The dashcam reboots automatically once-a-day if in parking mode at the set time for improved stability. If the dashcam is recording at the set time, the scheduled reboot is skipped.

You can enable/disable and change the time for scheduled rebooting. Default time is 03:00 am.

■ Speed alert

Set a speed limit (up to 300 km/h or 200 MPH) for the speed alert. When the vehicle exceeds the specified speed limit, the dashcam beeps and switches to event recording. After saving one event recording file the dashcam switches back to normal mode recording.

To make use of speed alerts an external GPS receiver must be connected to the dashcam.

■ User text overlay

You can create a user text overlay of up to 20 characters using a combination of English letters (A – Z, a – z), numbers (0 – 9), and symbols (;:/+_-()\$#). The text is overlaid in the top-left corner of the recorded videos.

□ Wi-Fi settings

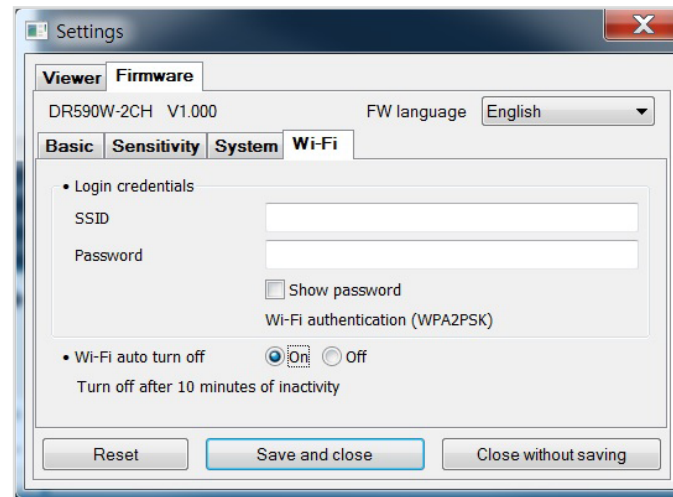

■ Login credentials

You can change the dashcam's SSID and Wi-Fi login password.

■ Wi-Fi auto turn off

When the Cloud service is enabled the Wi-Fi auto turn off setting cannot be adjusted. Wi-Fi will automatically switch on when you turn on the dashcam and remain on.

If you disable the Cloud service, you will be able to adjust the Wi-Fi auto turn off setting.

	ON	OFF
Wi-Fi auto turn off	Wi-Fi turns off if it is inactive for 10 minutes.	Wi-Fi does not turn off automatically.

□ Applying the settings

You can automatically apply the configuration by inserting the microSD card into the BlackVue dashcam and turning it on. Configure the settings before using the dashcam.

To reset the settings in the current tab to their defaults press the **Reset** button at the bottom of the settings panel.

➤ GPS receiver (Optional)

If you do not install an external GPS receiver, videos are recorded without GPS coordinates and driving speed information. To include speed, recording location, and the driving route data in the videos, install an external GPS receiver.

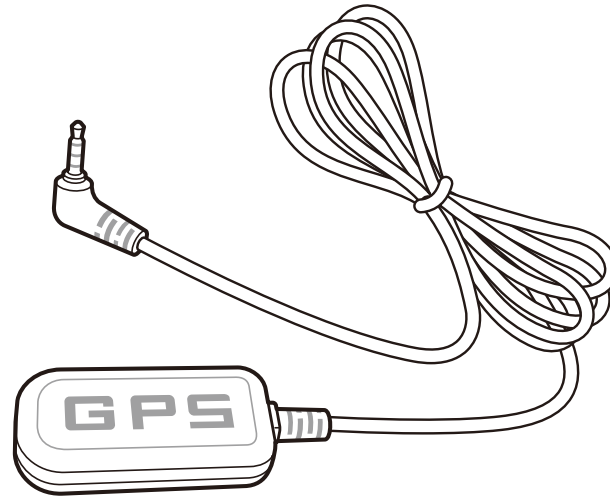

Note

- If you purchased the product without an external GPS receiver, please visit the BlackVue website (www.blackvue.com) for information about purchasing a GPS receiver separately.

➤ Parking mode hardwiring kit (Optional)

The BlackVue dashcam will turn off when the engine is turned off. To record video while the engine is turned off, a hardwiring kit (such as the Power Magic Pro) is required. The Power Magic Pro powers your dashcam when the engine is off by hardwiring it to the automotive battery. A low voltage power cut-off function and a parking mode timer protect your vehicle's battery from discharge.

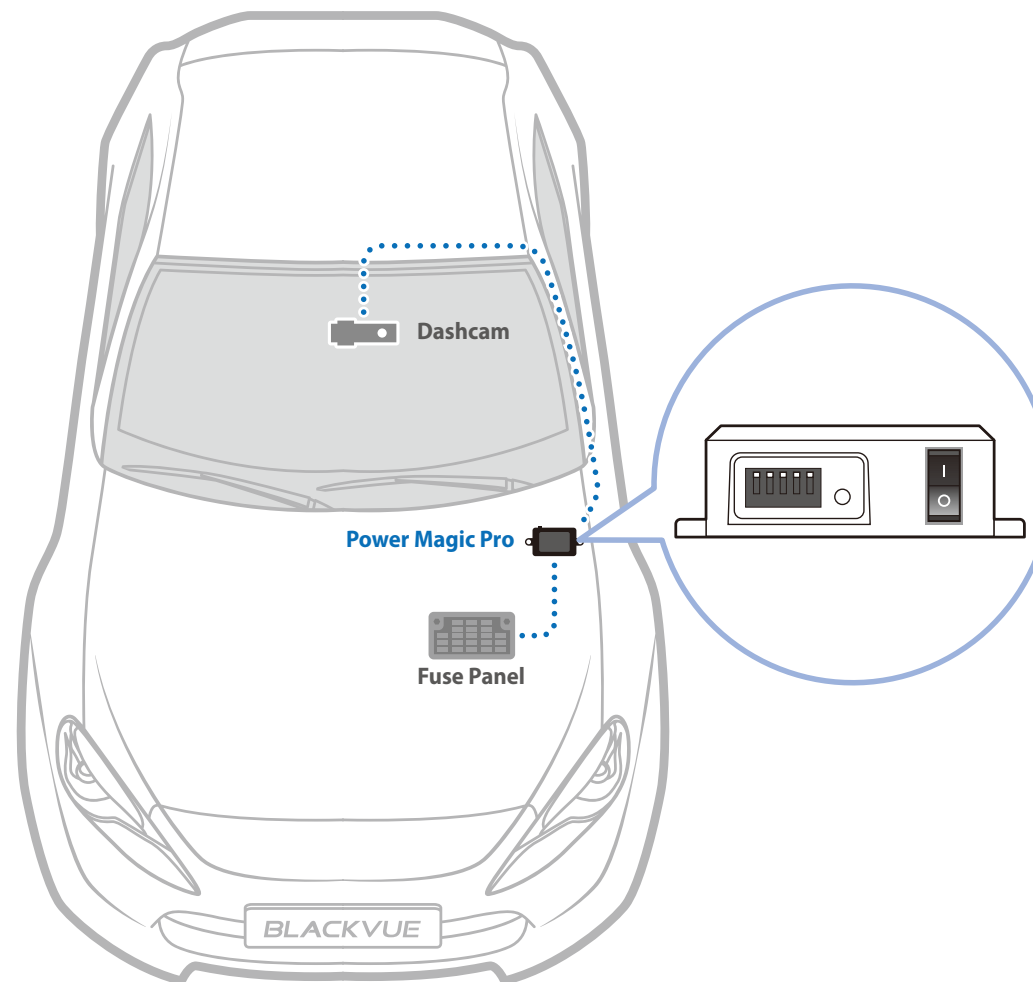

➤ Parking mode battery pack (Optional)

To record video when the engine is turned off without using the vehicle's battery, you can install a parking mode battery pack. The Power Magic Battery Pack B-112 powers a single dashcam for up to 12 hours after 1 hour of rapid charging. When the engine is off the battery pack powers the dashcam. When the engine is on the dashcam is powered directly from the vehicle's battery and the battery pack charges.

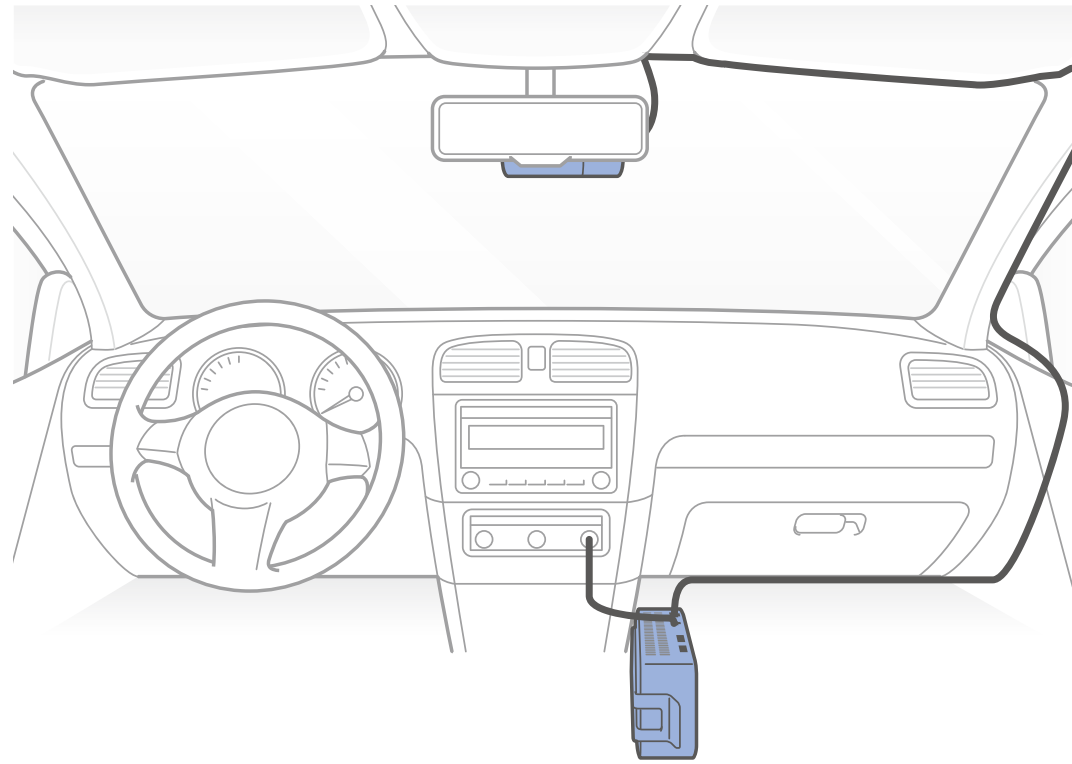

Changing / resetting direct Wi-Fi SSID and password



The dashcam's Wi-Fi SSID and password can be changed/reset using one of the following methods.

On-device Wi-Fi SSID and password reset

Press and hold the Wi-Fi button on the dashcam for 5 seconds and once voice instructions start, release the button. Then press once again to reset the Wi-Fi SSID and password to default.

*The default Wi-Fi SSID and password can be found labeled on the front camera when you remove it from its mount.

➤ Change the Wi-Fi password using BlackVue Viewer (Windows or Mac)

- 1 Remove the microSD card from the dashcam.
- 2 Insert the card into the microSD card reader and connect it to a computer.
- 3 Launch BlackVue Viewer.
*You can download **BlackVue Viewer** from www.blackvue.com > **Support** > **Downloads** and install it on your computer.
- 4 In BlackVue Viewer click on the  **Settings** button (Windows) or the  **BlackVue Viewer** menu (macOS) to open the BlackVue settings panel.
- 5 Click the **Firmware** tab, then the **Wi-Fi** tab and under **Login credentials** change the password.
- 6 Click **Save and close**.

Product specifications

Model Name	DR590W-2CH
Color/Size/Weight	Front: Black / Width 111.8 mm x Height 34 mm / 64 g Rear: Black / Width 67.4 mm x Height 25 mm / 21 g
Memory	microSD Card (16 GB/32 GB/64 GB/128 GB)
Recording Modes	Normal Recording, Event Recording (when impact is detected in normal and parking mode) and Parking recording (when motion is detected) * For parking mode recording, a Parking Mode Battery Pack (Power Magic Battery Pack) or a Parking Mode Hardwiring Kit (Power Magic Pro) is required.
Camera	Front: STARVIS™ CMOS Sensor (Approx. 2.1 megapixels) Rear: CMOS Sensor (Approx. 2 megapixels)
Viewing Angle	Front: Diagonal 139°, Horizontal 116°, Vertical 61° Rear: Diagonal 140°, Horizontal 115°, Vertical 60°
Resolution/Frame Rate	<Front - Rear> Full HD (1920x1080) @ 30 fps - Full HD (1920x1080) @ 30 fps Full HD (1920x1080) @ 30 fps - HD (1280x720) @ 30 fps HD (1280x720) @ 30 fps - HD (1280x720) @ 30 fps
Image Quality	Highest/High/Normal
Video Compression Mode	MP4
Wi-Fi	Built-in (802.11n (2.4 – 2.4835 GHz))
GPS	External (Optional)
Microphone	Built-in
Speaker (Voice Guidance)	Built-in

* STARVIS is a trademark of Sony Corporation.

LED Indicators	Front: Front Security, REC, GPS, Wi-Fi Rear: Rear Security LED
Button	Short press: Wi-Fi on/off Press and hold: Format microSD card
Sensor	3-Axis Acceleration Sensor
Backup Battery	Built-in super capacitor
Input Power	DC 12V – 24V (DC Plug:  (Ø3.5 x Ø1.35), MAX 1A/12V)
Power Consumption	Avg. 300mA (3.60W at 12V, when Wi-Fi is off and no external GPS receiver is connected) Avg. 350mA (4.20W at 12V, when Wi-Fi is on and an external GPS receiver is connected) * Actual power consumption may vary depending on use conditions and environment.
Operation Temperature	-20°C – 70°C (-4°F – 158°F)
Storage Temperature	-20°C – 80°C (-4°F – 176°F)
High Temp. Cut-Off	Approx. 70°C (158°F)
Certifications	FCC, CE, RoHS, Telec, WEEE, IC
Software	BlackVue Viewer * Windows XP or higher and Mac Yosemite OS X (10.10) or higher
Application	BlackVue Application (Android 4.4.2 or higher, iOS 9.0 or higher)
Other Features	Adaptive Format Free File Management System

Recording time

Your dashcam will automatically turn on and start recording when it is connected to a power source.

Memory Capacity		Image Quality	Resolution		
			FHD @ 30 + FHD @ 30	FHD @ 30 + HD @ 30	HD @ 30 + HD @ 30
16GB		Highest	1 HR 25 MIN	1 HR 35 MIN	2 HR
		High	1 HR 50 MIN	2 HR	2 HR 40 MIN
		Normal	2 HR 20 MIN	2 HR 40 MIN	4 HR
32GB		Highest	2 HR 50 MIN	3 HR 10 MIN	4 HR
		High	3 HR 40 MIN	4 HR	5 HR 20 MIN
		Normal	4 HR 40 MIN	5 HR 20 MIN	8 HR
64GB		Highest	5 HR 40 MIN	6 HR 20 MIN	8 HR
		High	7 HR 20 MIN	8 HR	10 HR 40 MIN
		Normal	9 HR 20 MIN	10 HR 40 MIN	16 HR
128GB		Highest	11 HR 20 MIN	12 HR 40 MIN	16 HR
		High	14 HR 40 MIN	16 HR	21 HR 20 MIN
		Normal	18 HR 40 MIN	21 HR 20 MIN	32 HR
Bit rate	Front	Highest	12 Mbps	12 Mbps	8 Mbps
		High	10 Mbps	10 Mbps	6 Mbps
		Normal	8 Mbps	8 Mbps	4 Mbps
	Rear	Highest	10 Mbps	8 Mbps	8 Mbps
		High	8 Mbps	6 Mbps	6 Mbps
		Normal	6 Mbps	4 Mbps	4 Mbps

Note

- If the microSD card is full, older files are deleted first to make space for newly-recorded videos.
- Total recording time is different depending on the memory capacity of the microSD card and the resolution of the video.

Disposal of your BlackVue dashcam



1. All electrical and electronic products should be disposed of separately from the municipal waste stream via designated collection facilities appointed by the government or the local authorities. Contact local authorities to learn about disposal and recycling options available in your area.
2. The correct disposal of your BlackVue dashcam will help prevent potential negative consequences for the environment and human health.
3. For more detailed information about disposal of your BlackVue dashcam, please contact your city office, waste disposal service or the shop where you purchased the product.

Customer Support

For customer support and firmware updates please visit www.blackvue.com

You can also email a Customer Support expert at cs@pittasoft.com

Before Requesting Service

Please back up all important files and data before requesting service. In order to service the dashcam it may be necessary to delete all files and data from the dashcam. All servicing is provided on the basis that the user has backed up all necessary files and data before requesting service. Therefore Pittasoft Co., Ltd. will not be responsible for the loss of any files or data.

Copyright & Trademark

- This instruction manual is protected by Copyright Law, and all rights to it are protected by law.
- It is prohibited to reproduce, copy, modify, or translate this instruction manual without permission.

 **BLACKVUE** BlackVue is the registered trademark of Pittasoft Co., Ltd. Pittasoft Co., Ltd. reserves all rights regarding all works related to the BlackVue brand such as product design, trademarks, and product-promotional videos. It is prohibited to reproduce, copy, modify, or use related works without permission. Any violation may be penalized in accordance with the relevant regulations.



FCC ID : YCK-DR590W-2CH / HVIN : DR590W-2CH / IC : 23402-DR590W2CH

Product | Car Dashcam

Model Name | DR590W-2CH

Manufacturer | Pittasoft Co., Ltd.

Address | 7F, BYC HIGHCITY Building A 131, Gasan Digital 1-ro, Geumcheon-gu, Seoul, Republic of Korea, 08506

Customer Support | cs@pittasoft.com

Product Warranty | One-Year Limited Warranty

 facebook.com/BlackVueOfficial

www.blackvue.com

Made in Korea